



Roofing Accessories

for Drainage and Substrate Ventilation



A comprehensive range for use with Butynol, EPDM and Bituminous Torch-on waterproofing membranes

For Butynol and EPDM membranes only



BT 200 Rainhead
Moulded rainhead with overflow. To suit 100mm or 150mm downpipe.

Complies with E1/AS1 5.5.1
An internal gutter overflow outlet should be located to give an early, conspicuous warning to the building occupier that maintenance is required.

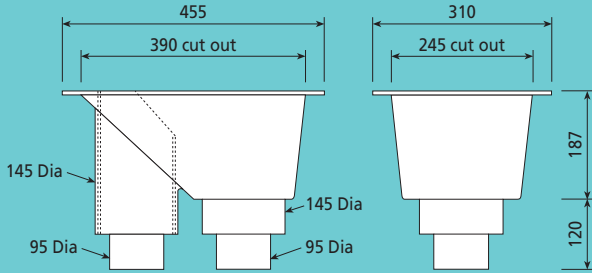

BT 204 Rainhead
Moulded rainhead with overflow. To suit 150mm or 200mm downpipe.

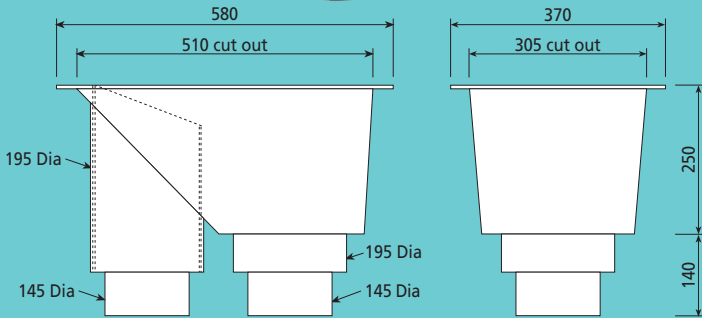

BT 205 Rainhead
Moulded rainhead with overflow. To suit 100mm or 150mm downpipe.

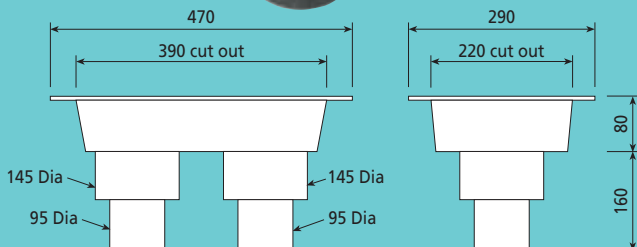

BT 202 External Rainhead
Moulded rainhead with metal fixing strip. To suit 100mm or 150mm downpipe. Can be used in conjunction with BT 301 Scupper.

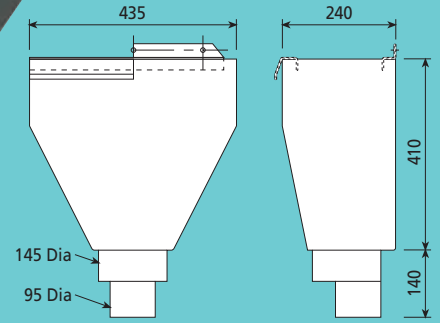

BT 203 Square Rainhead
Moulded rainhead, 295mm square. To suit 100mm or 150mm downpipe.

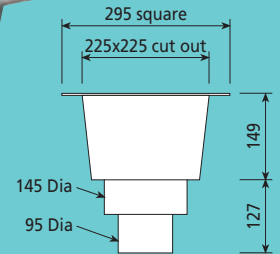

BT 300 Scupper

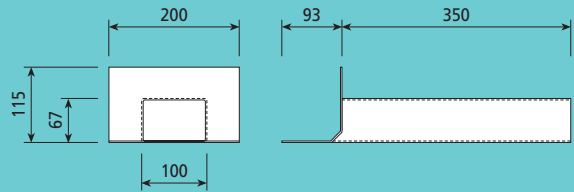

BT 301 Scupper

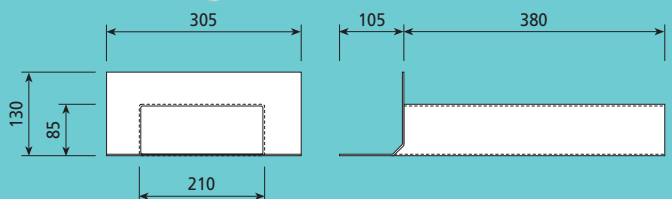
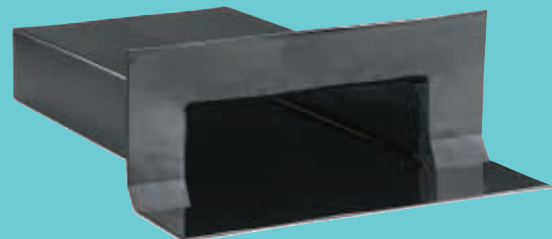

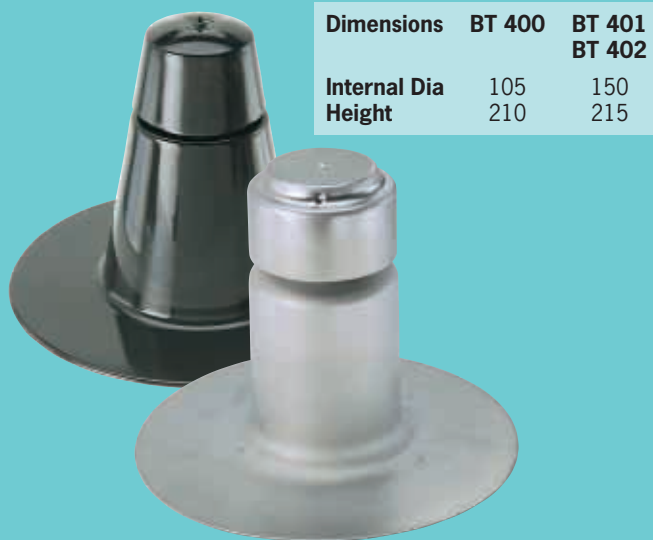

BT 100, BT 101, B102 Droppers

To suit 100mm (BT 100), 80mm (BT 101), 150mm (BT 102) downpipes.

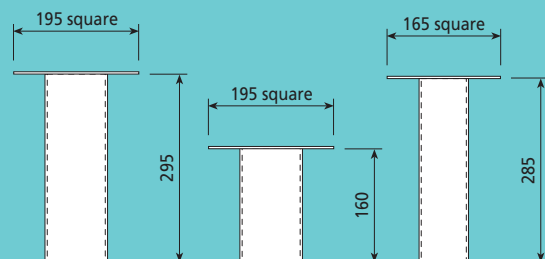

BT 400, BT 401, BT 402 Roof Vents

These one-way ventilators are available in spun aluminium (BT 400) or moulded polyethylene Black (BT 401), Grey (BT 402) for use on concrete or plywood substrates.



BT 602, BT 603 Plastic Deck Drain

Flat white plastic.
BT 602 - 80mm
BT 603 - 100mm

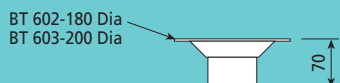

BT 606, BT 607 Dome Deck Drain

Bronze cast dome and insert.
BT 606 - 80mm
BT 607 - 100mm

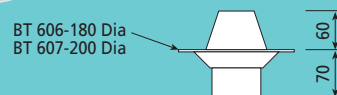

BT 604, BT 605 Chrome Deck Drain

Flat chrome insert.
BT 604 - 80mm
BT 605 - 100mm

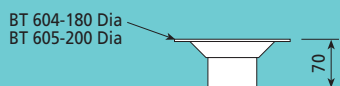

BT 608, BT 609, BT 610 Drain

3 piece unit with clamp
BT 608 - 80mm
BT 609 - 100mm
BT 610 - 150mm

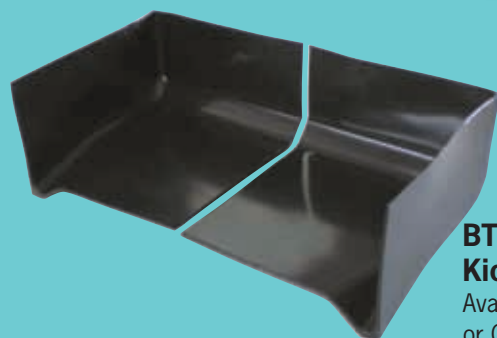
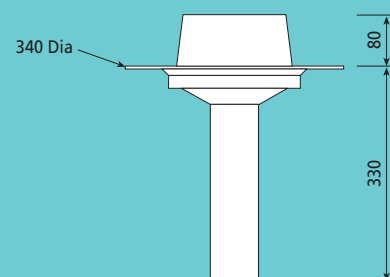

BT 700, BT 701 Kickout Flashing

Available in Black (BT 700) or Grey (BT 701)

Leafguards



BT 500 Leafguard

Moulded from tough PVC to suit 80-140mm outlets such as the BT 100 Dropper above.



BT 501 Leafguard

Moulded from tough PVC to suit 100-180mm outlets.

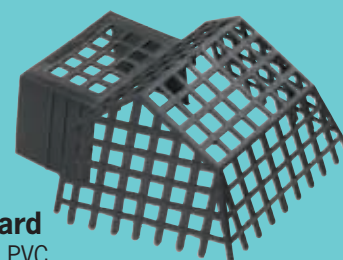

BT 502 Leafguard

Moulded from tough PVC. Fits into BT 300 Scupper.

For Torch-on and other membranes where by-laws permit



BT 302 Scupper

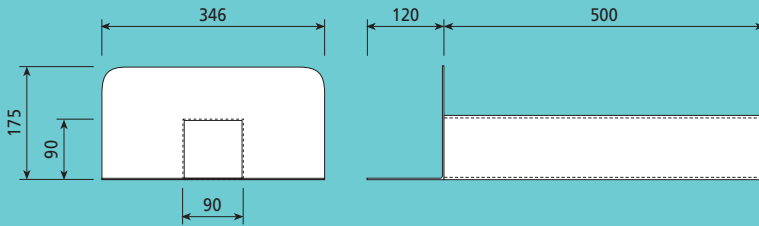

BT 103 Dropper
To suit 100mm downpipe.

BT 104 Dropper
To suit 80mm downpipe.

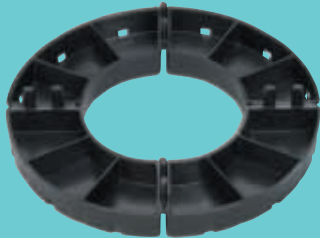
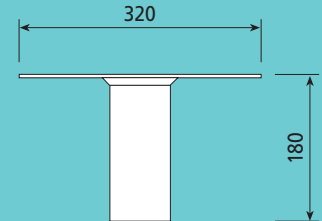

BT 420 Paver Support

Protects membrane against damage from heavy paving slabs. For use over external membrane.



BT 608, BT 609, BT 610 Drain

3 piece unit with clamp
BT 608 - 80mm
BT 609 - 100mm
BT 610 - 150mm

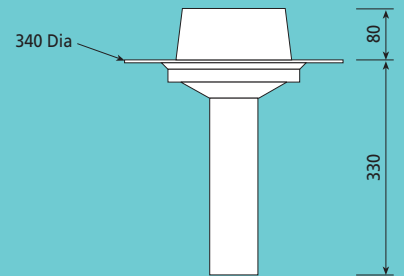

Maxi Adjustable Support

An adjustable paving support for floating paving systems. Adjustable height from 35-220mm. Available on indent order.

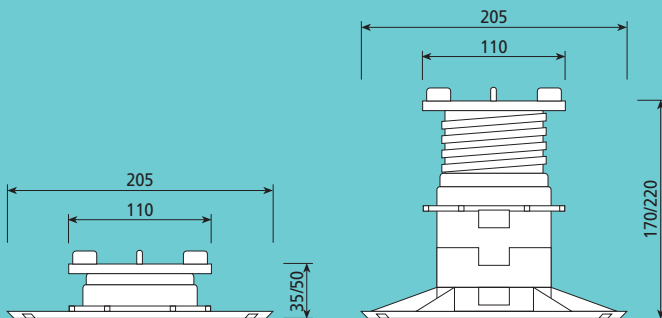

BT 400 Roof Vent

This one-way ventilator is in spun aluminium for use on concrete or plywood substrates.

Dimensions	BT 400
Internal Dia	105
Height	210



BT 355, BT 360 Scupper Downpipe Connector

Connects to BT 302 80mm or 100mm Scuppers.
BT 355 - 100mm
BT 360 - 80mm



ARDEX NEW ZEALAND LTD
Auckland Ph 09-580 0005
Wellington Ph 04-568 5949
Christchurch Ph 03-384 3029

www.butynol.co.nz

