



TPO ULTRAPLY

Technical Guidelines

Firestone
NOBODY COVERS YOU BETTER™



DESIGN

Firestone
NOBODY COVERS YOU BETTER™

1 Design

Many aspects and conditions need to be taken into consideration to build a long-term performing roofing system. The system is only technically acceptable if all requirements outlined in this chapter have been met and if general codes of practice, national and international regulations and installation specifications have been complied with.

It is imperative to identify the conditions of the project and the required performance characteristics of all roof components (roof deck, thermal insulation, vapor control layer, roof membrane) early in the design process. The Firestone UltraPly™ TPO roofing system should optimally respond to these requirements, local building codes and the selected design criteria.

Specifiers, contractors and building owners will find in this chapter information regarding the following topics:

1.1	Applicability	1.3
1.2	Structural design	1.8
1.2.1	Profiled steel decks	1.9
1.2.2	Appropriate (non-steel) decks	1.11
1.2.3	Critical decks	1.13
1.2.4	Slope / Shape / Drainage	1.14
1.2.5	Parapets / Walls	1.16
1.2.6	Expansion joints	1.18
1.3	Substrate preparation	1.19
1.3.1	Substrate requirements	1.19
1.3.2	Re-roofing considerations	1.21
1.3.3	Cover boards	1.24
1.4	Thermal design	1.26
1.4.1	Vapor control	1.27
1.4.2	Thermal insulation	1.29
1.4.3	Calculation and design	1.35
1.5	System design	1.38
1.5.1	Membrane selection	1.39
1.5.2	Fire performance	1.41
1.5.3	Wind design	1.42
1.5.4	Systems of attachment	1.45
1.5.5	Insulation and cover board attachment	1.55
1.5.6	Membrane attachment	1.61
1.5.7	System selection tables	1.66
1.6	Detailing	1.71
1.6.1	Base tie-in	1.72
1.6.2	Flashing of walls and curbs	1.73
1.6.3	Roof penetrations	1.75
1.6.4	Wall and roof edge terminations	1.77
1.7	Protection and maintenance	1.78

The responsibility for the selection of products supplied by other manufacturers and the effectiveness and compatibility of these products rests exclusively with the designer and the respective manufacturer. The specifier/roofing contractor should, in addition to Firestone guidelines, also comply with the instructions of the manufacturer concerned, taking into consideration the same principles of assessment outlined in this chapter.



1.1 Applicability



Picture 1.1 - Bridgestone factory - Hungary



Picture 1.2 - Olympic Stadium (athletics) - Rio, Brazil



Picture 1.3 - Etihad Museum - Dubai, UAE



Picture 1.4 - Shopping center - Mouscron, Belgium

UltraPly™ TPO membranes are mainly suitable for roofing applications on commercial, industrial, public and administration buildings, including sport arenas.

UltraPly™ TPO membranes cannot be applied on roofs where structural conditions are insufficient to support the load of the completed roof installation and/or anticipated loads, as identified by the designer.

As the use of the building and/or roof can have a significant impact on the selection and design of the roofing system, specific considerations need to be made and a special approval from Firestone's technical department is required for roofs and buildings that are subject to conditions described on the following pages.

The installation of UltraPly™ TPO membranes on non-roofing applications such as plaza deck construction, basement waterproofing and lining is not covered by this document since other criteria need to be met.

Firestone recommends to contact local building authorities or to consult Firestone's technical department for applications on roofs subject to local code requirements or special regulations (FM, etc.) not mentioned or explained in this chapter.

Positive internal pressure



Picture 1.5 - Lidl distribution center - Genk, Belgium

This is often associated with high-rise office/residential towers, clean-room facilities, canopies or overhangs and with buildings with large openings in a wall (greater than 10% of the wall surface) which could accidentally be left open in a storm, such as aircraft hangars and distribution centers with multiple overhead doors.

In all these situations, positive internal pressure can adversely act on the underside of the roofing system, billow up the membrane and reduce the overall wind uplift resistance of the system.

Design considerations:

- Use an air-impermeable deck (in situ poured concrete)
- Install an air barrier at deck level beneath the insulation on air-permeable decks (metal deck, wood, etc.)
- Pay specific attention to the design of critical wind zones (areas with higher wind pressures and therefore a higher density of fastening system) at canopies, overhangs and large wall openings.
- Use insulation boards with adequate facer in case of a fully adhered or induction welded system

Specific topographic location



Picture 1.6 - Eishalle - Inzell, Austria

Buildings located in areas that are exposed to additional wind pressure, such as down slope areas of hills, ridges and escarpments.

Design considerations:

- Consult local methods of wind design to adjust wind speed (pressures) in accordance with the specific topographic situation.

Differences in vapor pressure (inside/outside)



Picture 1.7 - Indoor swimming pool

These conditions are usually associated with swimming pools, paper/pulp mills, food processing plants and smelting furnace facilities. Typical for these buildings is the big difference in vapor pressure (relative humidity) between the inside and the outside of the building. This can result in condensation within the roof assembly.

A similar situation of extreme difference between inside and outside vapor pressure occurs with cold storage/freezer buildings, where the roofing system needs to be protected from external vapor (moisture) trying to penetrate the building.

Design considerations:

- Limit the number of penetrations through the deck and roofing system
- Install an appropriate vapor control system that combines an efficient vapor control layer and thermal insulation at deck level to control the vapor flow through the roof assembly
- Pay specific attention to roof details at parapets and penetrations to assure a vapor tight seal
- Use closed-cell foam insulation to minimize risks for condensation and degradation of the roof system
- Avoid attachment methods that puncture the vapor control layer
- Use in preference adhesives to attach insulation, cover board and membrane

Contamination



Picture 1.8 - Carrasco International Airport - Montevideo, Uruguay

These conditions are most often identified on restaurants, food processing, pharmaceutical and chemical plants, manufacturing facilities and airports where the roofs are exposed to grease, oil or discharge of chemical substances more than normal airborne contaminants.

Unforeseen combinations of contaminants, reactions due to environmental exposure and variations in contaminant concentrations often make it hard to predict the long-term resistance of the roofing system.

Design considerations:

- Limit exhaust of contamination, i.e. installation of grease traps
- Plan a periodic inspection and washing of the roofing membrane
- Isolate contaminated areas where frequent replacement of roofing membrane is expected

Green roofs



Picture 1.9 - Green roof

Green roofs consisting of vegetation installed on top of the Firestone UltraPly™ TPO roofing membrane have become an integral part of the landscape. The UltraPly™ TPO membrane has successfully passed various tests of resistance to root penetration and is therefore compatible with extensive and intensive vegetation.

Design considerations:

- Adapt the load bearing capacity of the roof deck in accordance to the loads to be expected, including weight of vegetation, water, traffic during maintenance, etc.
- Use insulation with sufficient compressive strength or a cover board as direct substrate for the membrane
- Use of a thicker membrane (min 1.5 mm) is recommended
- Design an appropriate drainage system
- Fully adhered applications are preferred
- Foresee areas free of vegetation around upstands and roof penetrations

Photovoltaic installations



Picture 1.10 - Duvel distribution center - Puurs, Belgium

Flat roofs covered with light colored reflective UltraPly™ TPO roofing membranes are frequently used for installation of photovoltaic systems. To assure the efficiency of the roof system, the following specific design considerations need to be considered:

- Design the roof structure to absorb wind loads and the weight of the photovoltaic installation
- Pay specific attention to provide a minimum slope
- Use insulation with sufficient compressive strength or a cover board as direct substrate for the membrane
- Fully adhered applications are preferred
- Use of a thicker membrane (min 1.5 mm) is recommended
- Install a walkway pad system to protect the roofing membrane in areas of intensive traffic
- Specific detailing for roof penetrations is required
- Design the roofing system taking into consideration an easy maintenance when the photovoltaic equipment has to be repaired

Frequent foot traffic and physical abuse



Picture 1.11 - Walkway protection

Some roof installations are expected to experience a high degree of foot traffic due to the maintenance of rooftop equipment. Other installations need to be protected against vandalism, unauthorized access, prolonged periods of extreme temperatures and UV-radiation, hailstorms, etc.

Design considerations:

- Use insulation with higher compressive strength or a cover board as direct substrate for the membrane
- Use a thicker membrane (min. 1.5 mm)
- Install Walkway Pads or concrete pavers in areas exposed to intensive traffic
- Consider an inverted roofing system on roofs with heavy traffic.

Parking decks



Picture 1.12 - Bpost distribution center - Belgium

As the number of cars increases exponentially, there is a growing need for parking space. Flat roofs can be used as parking decks when the structure of the building is designed to absorb the static and dynamic loads of vehicles circulating on top, in addition to the weight of the complete roof. This requires a thorough study. The roof build-up of a parking deck is complex since all materials applied must resist the stresses caused by these loads and need to be protected against the attack of chemicals (hydrocarbons, salt, etc.) and adverse climatological conditions (extreme changes in temperature, frost, condensation, etc.).

Design considerations:

- Provide a sufficient slope (min 2%)
- Drainage of the top surface needs to be designed to avoid an overload due to accumulation of water/snow (gutters, drains, overflows)
- Design all components of the roofing system, including vapor control layer, insulation, membrane and their method of attachment in such a way that they can absorb the anticipated loads and stresses.
- Use only insulation with the highest compressive strength. Appropriate boards are cellular glass and extruded polystyrene.
- Use a membrane with a thickness of minimum 1.5 mm
- Install in preference a fully adhered membrane system
- Pay specific attention to design of drainage and protection layers on top of the membrane.

1.2 Structural design



Picture 1.13 Construction airport terminal - Montevideo, Uruguay

It is the responsibility of the engineer, architect, roofing contractor and building owner to verify if the structural conditions of the roof are suitable for the installation of a Firestone UltraPly™ TPO roofing system. Firestone assumes no liability for structural analysis but strongly recommends that a structural engineer be consulted in case of doubt prior to roof specification and/or job start.

It is also the responsibility of the engineer, architect, roofing contractor or building owner to select the appropriate type of deck and verify its suitability for the installation of a Firestone UltraPly™ TPO roofing system. In case of doubt with regards to the properties of the deck, Firestone recommends to first verify the information provided by the supplier.

The roof deck serves as a primary support for the roofing system. It transfers the weight of live and dead loads to supporting purlins, joists and beams. Live loads include snow, rain, moving installation equipment and wind. Dead loads include skylights, HVAC units, roof deck, thermal insulation, membrane and ballast (or vegetation).

Roof decks also serve as a base to anchor all components of the covering roof system (vapor control layer, insulation, cover board, membrane, skylights, roof edge profiles, etc...). Its condition is therefore extremely important for the long-term performance of the Firestone UltraPly™ TPO roofing system.

For applications where the membrane will be covered with ballast or vegetation, the designer must consider the weight of ballast required to comply with local wind uplift requirements when determining the structural ability of the deck. Under normal conditions, ballasted and inverted roofing systems require a minimum load of 50 kg/m² in the field area of the roof and for some cases up to or more than 100 kg/m² in perimeter and corner areas.

For insulated decks, wood nailers of the same thickness as the insulation must be installed at perimeters and roof openings. These nailers will serve as an insulation stop and provide a base for mechanical attachment of the membrane, skylights and roof edge profiles.

Firestone UltraPly™ TPO roofing systems can be installed over most commonly applied structural roof decks, provided these decks meet with local standards, are structurally sound, guarantee sufficient pull-out resistance and are properly installed.

1.2.1 Profiled steel decks



Picture 1.14



Picture 1.15



Picture 1.16

The most commonly used metal decks for commercial buildings are made of galvanized steel covered with a thin layer of zinc (Z), zinc-aluminium (5%) (ZA) or aluminium (55%)-zinc (AZ) to provide protection against corrosion. In addition, some decks are coated. Stainless steel is an alternative in case a greater protection is needed. The steel should provide a minimum yield strength in accordance with local standards.

The load bearing capacity of the metal deck is determined by its thickness, yield strength and the design of its profile. Deck deflections should be limited as required by local codes to accommodate stresses of either concentrated or uniform loading.

Thickness should be minimum 0.75 mm (22 gauge) to provide a solid base for anchoring and to minimize deflection. Since the installation of fasteners is linked to their pull-out, thinner (<0.75 mm) and perforated decks require a pull-out test (Picture 1.15). On perforated decks (used to meet with acoustical requirements) mechanical attachment is only allowed when the flutes are not perforated.

Attachment on thinner decks occurs frequently in re-roofing projects over existing metal roofs or when attaching into sandwich panels. Use of a different type of fastener or installation of additional fasteners may be needed. Thicker steel decks (> 0.75 mm) require application of a different type of fastener.

Metal decking have a suitable profile featuring crowns that are wider than the respective throughs, as illustrated below. Refer to this illustration to identify the different parts/dimensions that describe a steel deck.

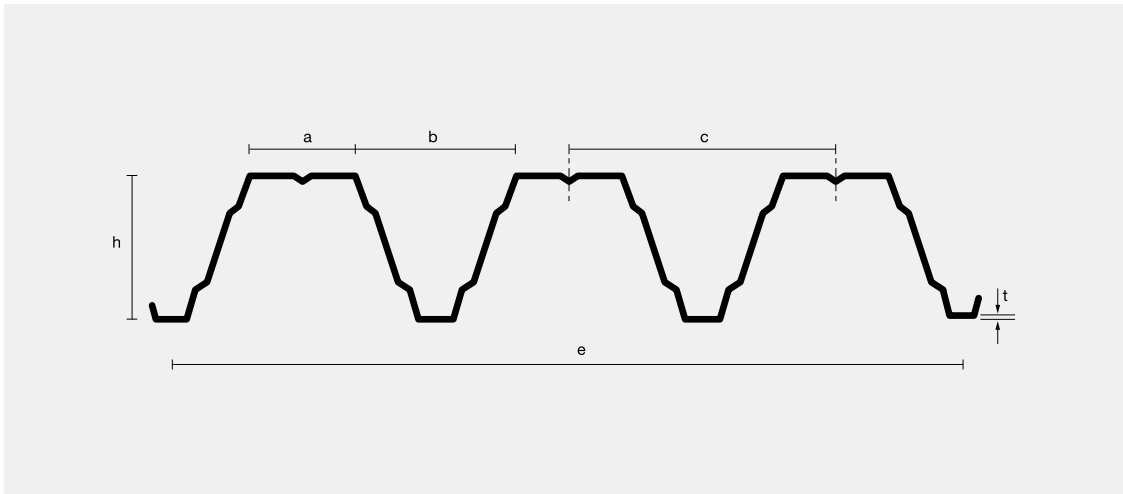

Figure 1.1 Dimensions steel deck - h: profile height, t: thickness, e: profile width, a: flute/crown width, b: span between flutes, c: corrugation width

Metal decks with higher profile or decks with thicker gauge are used to bridge bigger spans between the crowns or when the designer wants to increase the load without changing the span. It is the responsibility of the structural engineer to define the dimensions of the deck (deck profile, thickness, span and number of fields to bridge).

The deck profile has a direct impact on the positioning (and density) of the fasteners for membrane and insulation, as the span between the flutes of the deck varies in function of the type of profile. The deck profile has also an impact on the minimum required thickness of insulation.

Make sure the structural engineer designed the deck for the anticipated wind uplift loads at the perimeter and corner areas.

It is assumed that the deck be detailed in such a way that it provides adequate support for the insulation and for the anchoring of the field membrane at all perimeters, as illustrated.

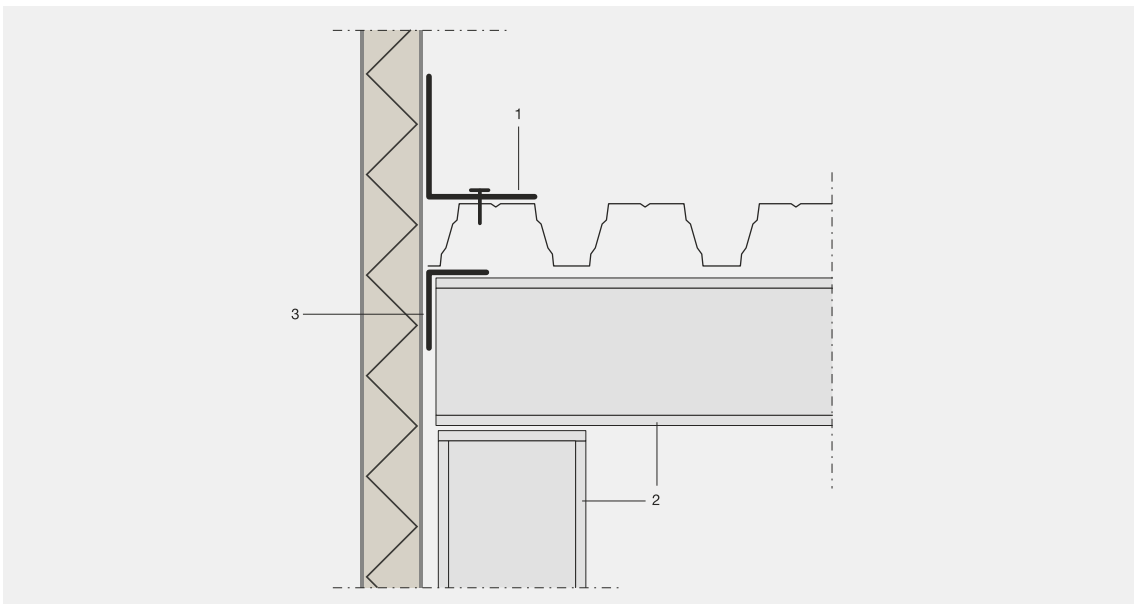

Figure 1.2 - Support steel deck at upstand - 1: L-profile to support insulation | 2: Steel structure | 3: L-profile to support steel deck

Metal decks should be reinforced at all roof penetrations where the size of the opening (at least one dimension) exceeds the corrugation width. For small penetrations (drains), this can be done by installing a steel plate. For bigger penetrations (skylights), the supporting substructure should be reinforced.

1.2.2 Appropriate non-steel decks



Picture 1.17



Picture 1.18



Picture 1.19



Picture 1.20



In-situ poured concrete (Picture 1.17)

- In-situ poured concrete should be solid and dense. If the deck serves as a base for mechanical attachment, the poured concrete should have a minimum grade (minimum strength) as defined by local standards and a minimum thickness of 100 mm. Concrete screeds are not appropriate for mechanical attachment.
- Finished surfaces should be provided by power or wood float and should be as smooth as possible when receiving a direct application of the roof membrane. All irregularities in the surface require grinding to result in a smooth and even substrate.
- Concrete must be properly cured and must be dry prior to installing the roofing system. Proper curing normally takes 28 days. The concrete may not contain more humidity than allowed to assure a durable bond in case the covering roof system will be attached directly to the concrete with adhesive. The acceptable moisture content needs to be determined by doing a test.
- Poured concrete and screeds contain considerable amounts of water and must provide the possibility for bottom side drying. Concrete decks poured over non-vented metal decks that remain in place can trap moisture under the roof system and therefore require specific attention.
- The underside of the concrete deck must remain unobstructed long enough to allow water or vapor to escape. For this reason, materials that slow the drying process of the concrete, such as foil-faced insulation, paint or spray-on fire proofing must not be installed directly at the underside of the deck.

Pre-cast concrete (Pictures 1.18 - 1.19)

Pre-cast concrete decks are commonly applied as a cost-effective and durable alternative to steel decks in industrial and commercial buildings. They are supplied as slabs made structural or lightweight concrete. Some decks are pre-stressed; others are without tension. Some are manufactured in T-slabs or double tees; others are made with hollow cores to minimize their weight, as illustrated.

- Structural and lightweight concrete should meet with minimum requirements of compressive strength as per local standards.
- Deformed panels or panels with too much deflection must be replaced. All joints should be filled with a grout (sand and cement mortar) unless the panels have a tongue and groove system. The grout should correct imperfections and differences in height between slabs. It should also avoid a transfer of stresses between adjoining panels. In some cases, installation of a screed is required to absorb excessive deflections.
- Mechanical attachment into concrete screeds is not allowed. In case of mechanical attachment in structural concrete, pre-drilling is required. Refer to section 1.5 (System design – fastening system) for specific information regarding fastening systems that are compatible for attachment into structural and lightweight concrete. Installation of fasteners in T-slabs is only allowed in the ribs.
- It is recommended not to install electrical cables in the concrete to prevent problems during the installation of the fastening system.

Wooden decks (Picture 1.20)

The following materials are acceptable:

- Seasoned timber board. Wood should be kiln dried
- Exterior grade plywood (minimum 3 plies)
- Exterior grade Oriented Strand Board (OSB), type OSB/3 or OSB/4
- Wooden decks should have a minimum thickness of 18 mm and shall be secured with appropriate fasteners at required spacing, in accordance to local codes or specific requirements. Refer to section 1.5 (System design – fastening system) for specific information regarding fastening systems that are compatible for attachment into wooden decks. Use of nails is not permitted.
- Verify that the products used to preserve and protect the wood (fire) are chemically compatible with the roofing membrane. Treated plywood may be used, provided it has not been treated with ammonium phosphates.
- Wooden planks must be supported at each end, clamped together, tongued and grooved or closely butted.
- Plywood and OSB boards must be installed so that all four sides of each panel are secured to joists with a 3 to 5 mm gap between panels.
- Wooden decks must be covered immediately after installation with the roofing system, including insulation and membrane.
- On re-roofing projects, attention must be paid to the condition of the existing deck. This includes moisture control, compatibility between deck and fastener, and chemical compatibility between deck and roof membrane.



1.2.3 Critical decks

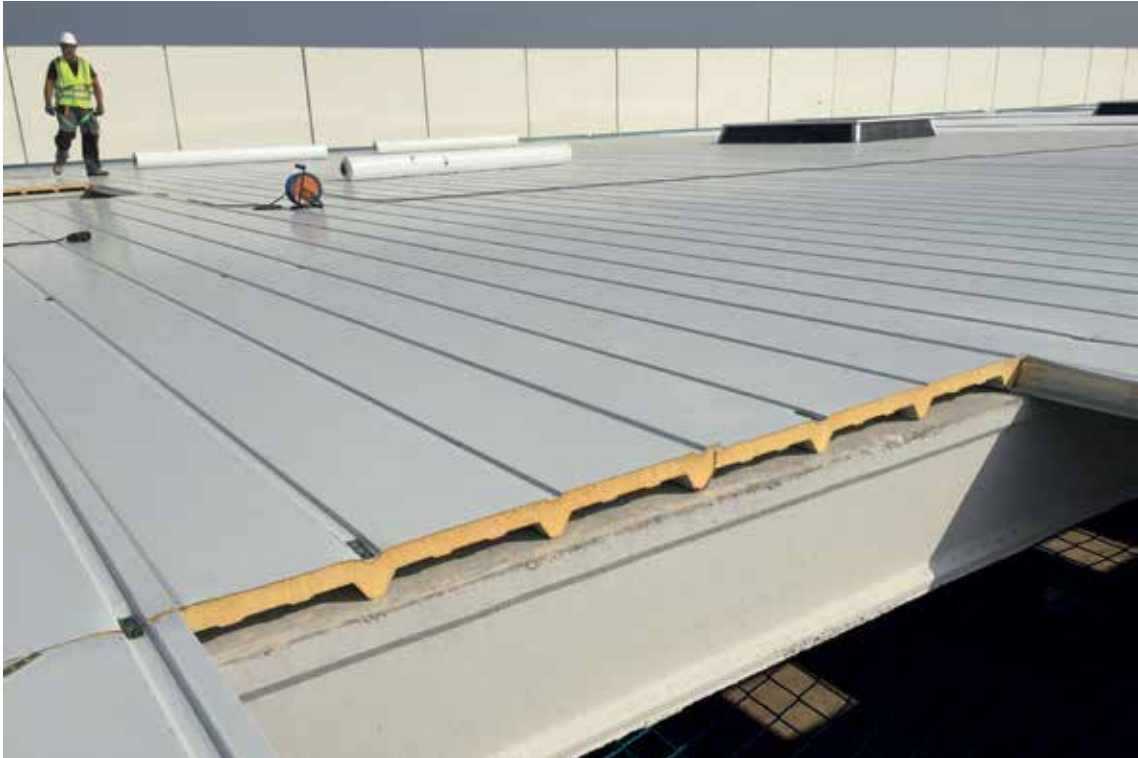

Picture 1.21

- Aluminium, thin steel decks and thin concrete decks are considered critical for mechanical anchoring the UltraPly™ TPO roofing system. These decks require use of a non-conventional fastening system. Refer to section 1.5 (System design) for specific information.
- Sandwich panels require specific attention. Most panels provide a thin metal sheet that requires a pull-out test prior to attachment. Some suppliers have specific recommendations for mechanical attachment in their panel to avoid delamination of the top sheet. Consult the recommendations of the deck supplier when designing a mechanically fastened roofing system on top of a sandwich panel. Use of a foam adhesive is a secure alternative in case mechanical attachment is not allowed.
- Wood-wool decks are not recommended for mechanically fastened roofing applications.

1.2.4 Slope / Shape / Drainage



Picture 1.22



Picture 1.23



Picture 1.24

Positive drainage

- Roof decks should be designed providing a fall for positive drainage to avoid pounding water at drain outlets and roof penetrations. Standing water can result in deck deflection and possible structural damage. In case of leaks, it can significantly worsen damage to the roofing system by providing a reservoir of water ready to infiltrate. Finally, standing water also makes it more complicated for roof maintenance and to assure aesthetics.
- Firestone's definition of inadequate drainage is a condition existing on any area of the roof where water remains for more than 48 hours after precipitation. As deck deflections should meet local standards and are generally limited to 1/200 of the total span, new constructions should have a minimum fall of 2% on all locations.
- Drains should be located at the lowest points of the roof (maximum deflection), not at columns or bearing walls (minimum deflection).
- Design of the drainage system, including location, dimensions and number of gutters, drains, scuppers and overflows depend on the parameters of the project (size and shape of roof, structure, slope, ...) and should be made by the architect or designer in accordance with local codes and standards.
- Refer to chapter 3 to identify some appropriate types of drainage systems that are compatible with UltraPly™ TPO roofing products.

- Positive drainage may be achieved by 3 methods, either providing a slope in the structure, providing a slope within the layers above the deck or by adding additional drains.

Slope in the structure can be provided by either:

- Adjustment of the height of beams and/or purlins
- Tapered supports
- Installation of firing pieces under the deck

Slope within the layers above the deck can be provided by either:

- Screed or an overlay of tapered lightweight cellular concrete
- Tapered insulation

- When an additional slope must be provided, attention should be given to provide proper flashing height at upstands, parapets, roof edges, windows, doors and around penetrations.
- Also, pay attention that the mechanical attachment of roofing systems on concrete decks with a screed is only allowed into the structural deck. This will result in the application of fasteners with different lengths.

In situations where roof conditions prevent a smooth and efficient functioning of the drain system exclusively provided by slope, one may consider a combination of tapered insulation and installation of additional drains.

Maximum slope

SLOPE		FIRESTONE ULTRAPLY™ TPO SYSTEM			
		MECHANICALLY FASTENED	INDUCTION WELDED	FULLY ADHERED	BALLASTED INVERTED
≤ 6 °	≤ 10%	A	A	A	A*
> 6 °	> 10%	A	A	A	A
Arch, Barrel shape		A	⚠	⚠	A
<p>Notes:</p> <p>A Applicable A* Applicable with restrictions Additional precautions should be taken to restrain movement of ballast in case the roof has a slope ≥ 5%. This can be done by:</p> <ul style="list-style-type: none"> - increasing size and weight of ballast - installation of min. 50 mm thick concrete pavers at lowest points <p>⚠ Requires further study by Firestone's technical department</p>					

Table 1.1 - Slope limitation

Installation of UltraPly™ TPO roofing systems also has its limitations on sloped roofs.

- Roof slopes are limited by installation conditions. Refer to the table below to verify the suitability of the selected UltraPly™ TPO roofing system (method of attachment of the membrane) in function of the designed slope and/or roof shape. Pay specific attention to verifying the welding conditions of your welding equipment and adjusting the welding parameters (speed, temperature) in function of the roof slope.
- Roof slopes are also limited by requirements for fire resistance of the designed UltraPly™ TPO roofing system. Refer to the section fire resistance or consult Firestone's technical department for additional information.

1.2.5 Parapets / Walls



Picture 1.25

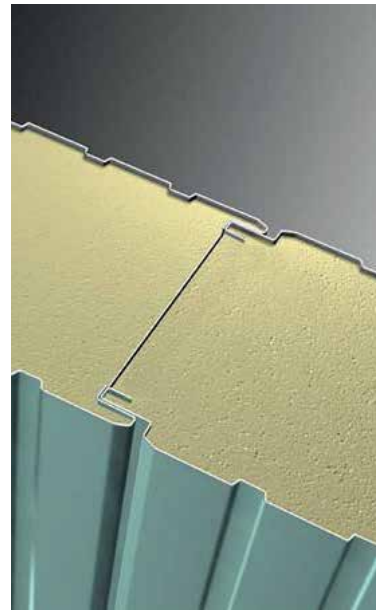

Picture 1.26



Picture 1.27



Picture 1.28



Picture 1.29

Parapets and interior walls serve as a direct support to adhere and/or mechanically attach membrane flashings and install base tie-in details.

It is the responsibility of the roofing contractor to verify the conditions of upstands and interior walls prior to the installation of the Firestone UltraPly™ TPO roofing system and assure that the substrate is suitable for the installation (mechanical anchoring and/or adherence) of the membrane flashing.

UltraPly™ TPO roofing systems can be installed over most commonly used structural wall substrates, provided they meet with local material standards, are structurally sound, guarantee sufficient pull-out resistance and offer an adequate substrate for direct application of the membrane. Consult the minimum requirements below for preparation of each specific substrate.

Metal *(Picture 1.26)*

Metal parapets are either profiled sheets from galvanized steel or sandwich panels.

- Metal sheets should have a minimum thickness of 0.63 mm and need to be structurally sound for attachment.
- Thinner sheets require a pull-out test. The fastening system needs to be adapted in function of the pull-out value (type of fastener, installation of additional fasteners or use of foam adhesive).
- Substrates can be smooth, with a very small profile (sandwich-panels) or corrugated.
- Corrugated panels require an overlayment with an appropriate cover board or insulation to provide a smooth substrate.
- Damaged or corroded panels need to be replaced prior to the installation of the roofing system.
- Specific attention should be paid to the design and execution of the base tie-in detail.

Concrete *(Picture 1.27)*

Parapets are usually made from structural or cellular concrete.

- Concrete needs to be structurally sound and requires a smooth (steel trowel or wood float) finishing. The substrate needs to be dry prior to the installation of the wall flashings.
- If flashing membranes are to be installed directly over the concrete substrate, verify that all irregularities are grinded to provide a smooth and even substrate. Uneven substrates require an overlayment with an appropriate cover or insulation board.
- Columns that support pre-cast concrete wall panels will result in extra detail work and complicate water drainage and should therefore be avoided.

Masonry *(Picture 1.28)*

- Parapets from bricks or concrete blocks with mortar joints need to be dry prior to flashing.
- Smooth finished bricks and concrete blocks with standard tooled mortar joints can receive direct installation of wall flashings.
- Textured bricks and blocks with deeply tooled joints require a cementitious coating or overlayment with an appropriate cover or insulation board to provide a smooth and even substrate.
- Stucco must be removed completely and the underlying substrate needs to be dry prior to installation of the flashing membrane.

Wood *(Picture 1.29)*

Parapets from massive wood, exterior-grade plywood or Oriented Strand Board (OSB), type OSB/3 or OSB/4.

- Only untreated boards with a minimum thickness of 16 mm should be used in case of adhered flashings.
- Wooden boards must be fastened with screws. Adhesion is an alternative if parapets can resist requirements for loading.
- The substrate needs to be dry prior to the installation of wall flashings.

1.2.6 Expansion joints



Picture 1.30



Picture 1.31

Structural expansion joints are used to minimize the effect of movements of building components and to prevent stresses from affecting normal functioning of the roofing system.

The need for expansion joints, as well as their type, design and location must be considered during design of the building and are exclusively the responsibility of the architect or structural engineer.

Area dividers are not considered as expansion joints. They are installed to separate different types of roofing systems.

Conditions that require expansion joints

Considerations should be made at all locations where:

- Expansion joints are provided in the building structure/deck
- Structural framing elements (joists, purlins or steel deck) change direction
- Different types of roof deck (e.g. steel/concrete) abut each other
- Junctions are made between spaces with different and changing temperature (e.g. cool storage/freezer)
- Additions are connected to existing buildings
- Movement is anticipated between wall and roof deck or between sections of roof deck (Pictures 1.30 - 1.31)
- Roof areas present dimensions larger than 60 m in any direction

Design considerations

The following specific considerations may assist in designing the expansion joint at roof level.

- Expansion joints should never be bridged with insulation or membrane but continue throughout the roof build-up. In most details a compressible infill (insulation material) is installed between the ends of the insulation boards to create a loop in vapor control layer and roofing membrane. The excess of material must absorb all thermal and structural movements.
- Expansion joints must be continuous along the interruption in the structure and may not terminate before the end of the roof deck. They should continue also in upstands.
- The drainage system must be designed in a way that normal drainage flows are not obstructed by the expansion joint.
- Pay attention to protect expansion joints in areas where foot traffic is expected. Proper design of walkway pads may be helpful.

Refer to Chapter 5 for additional information about basic design principles of expansion joints.

1.3 Substrate preparation



Picture 1.32



Picture 1.33

Substrates of roof deck and upstands should be inspected by the roofing contractor prior to the installation of the roofing system.

It is the responsibility of the contractor to verify if all substrates to be covered are suitable to receive the installation of the roofing system.

The information in this section may assist the specifier and contractor in identifying general substrate requirements for direct application of the UltraPly™ TPO membrane. We also provide information of cover boards (function, types), including the products offered by Firestone.

Finally, you will also find information about the topics that need to be addressed during re-roofing.

1.3.1 Substrate requirements

Substrates to be covered with the Firestone UltraPly™ TPO roofing membrane must meet with the following requirements:

SMOOTH

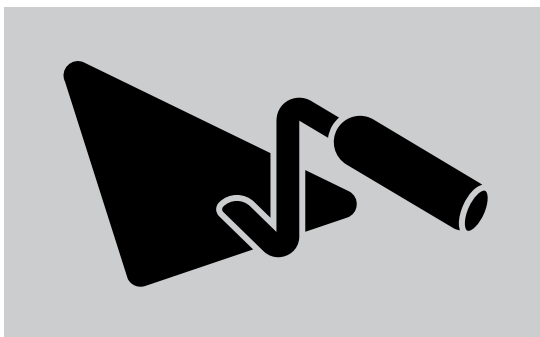

Smooth means free of sharp edges and fins. All rough surfaces that could damage the UltraPly™ TPO membrane and flashing materials should be properly covered with a leveling layer. Approved leveling materials are protection mats (geotextile), cover boards or thermal insulation.

To ensure the maximum service life of UltraPly™ TPO membranes in non-adhered applications, Firestone recommends to install a geotextile (min. 200 gr/m²) to separate the membrane from abrasive surfaces such as rough concrete, cementitious screeds and bituminous membranes. Abrasive surfaces require overlayment with an appropriate cover or insulation board in case of an adhered application.

STRUCTURAL SOUND WITHOUT VOIDS

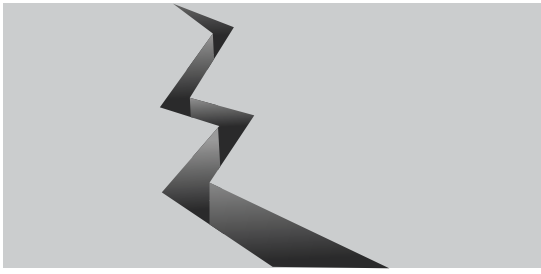

Substrates need to provide the required conditions for attachment and proper welding. All voids greater than 5 mm must be properly filled with an acceptable product (PU foam) or overlaid with a thermal insulation or cover board.

CLEAN



Heavy dirt and dust must be removed with a hard-bristled brush.

DRY

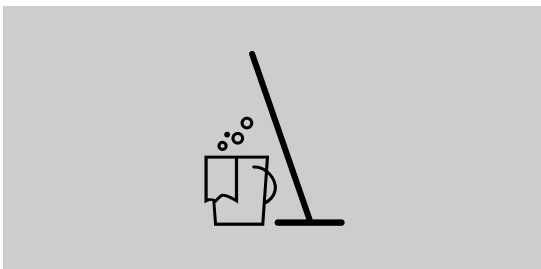

Ponded water, snow, frost and ice must always be removed. For fully adhered applications, substrates must be dry to assure a quality bond. A non-destructive test can be used to evaluate the moisture content within the concrete, cementitious screed or wood. (i.e. Tramex). Consult Firestone's technical department for more details.

NO HOT SURFACES



Any continuous contact between TPO products and heat sources over 60° C should be avoided.

CHEMICALLY COMPATIBLE

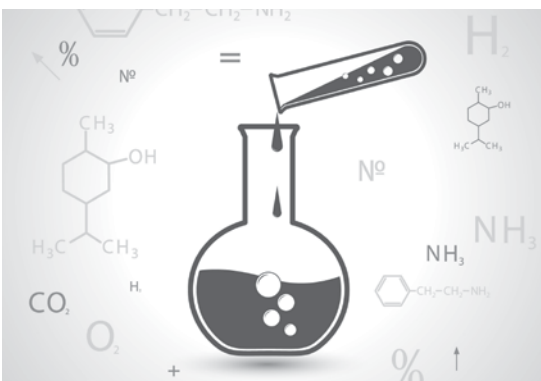

Any contact between TPO materials and incompatible products such as grease, animal fats, oil based products from mineral or vegetal origin, strong acids and fresh bitumen should also be avoided.

Consult Firestone's technical department if there is any doubt with regards to chemical compatibility.

1.3.2 Re-roofing considerations

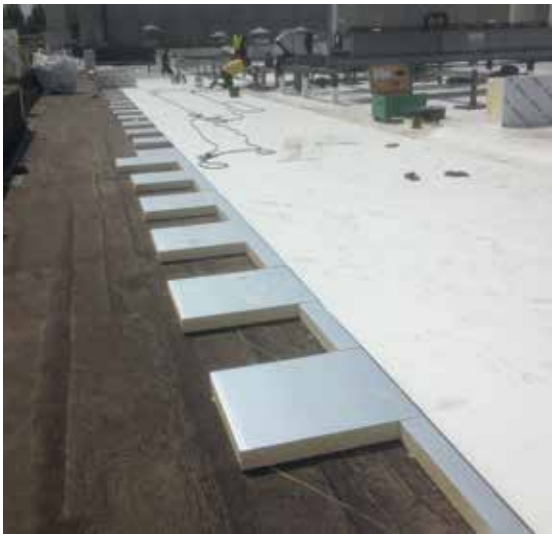

Picture 1.34



Picture 1.35

In re-roofing applications, the performance of the new roofing system depends on the quality and preparation of the existing roof. On top of the substrate considerations mentioned previously, additional measures need to be taken with regards to adaptation or replacement of the existing situation.

Although the list is not exhaustive, the following considerations typically need to be made for any re-roofing project.

Basic decision: tear-off or recover?

The most important decision to be made is often whether the existing roof has to be replaced (tear-off) or repaired (recover). The information in the table below may assist in taking that decision.

TYPE OF INTERVENTION	TEAR-OFF	RECOVER
BASE FOR DECISION	Provide a 100% sound substrate for the new roofing system	Eliminate defects of the existing roof to assure an acceptable performance of the new system
SUPPORTING FACTORS	<ul style="list-style-type: none"> structural limitations (load bearing capacity, deflection) flashing height limitations significant portion of existing roof is wet or degraded maximize long-term performance 	<ul style="list-style-type: none"> cost complicated roof access satisfying condition of existing roofing system including thermal performance assure continuity of activities in the building during installation
PRINCIPAL ACTIVITIES	Implement a good strategy for tear-off and installation of the new system, so that construction traffic is directed away from the new installation and roof drainage systems are never blocked. New roof areas adjacent to tear-off areas should be protected from contamination and damage	Concentrate on: <ul style="list-style-type: none"> surface preparation replacement of wet roofing materials correction of the drainage system

Table 1.2 - Guidelines to consider tear-off or recover



Picture 1.36



Picture 1.37

Control moisture content (Picture 1.36)

Thorough inspections are required for every re-roofing project to evaluate the moisture content of the existing roof. At this stage, errors of design need to be identified and all limiting factors that will influence the performance of the new system must be determined. The inspection must consider the condition of all components of the existing roofing system, including roof deck, vapor control layer, insulation and roofing membrane.

Replace damaged decks (Picture 1.37)

The contractor should always investigate the condition of the deck. Structural decks must be inspected to determine their capacity for taking the additional weight of the new system, including additional loads that occur during installation and due to the storage of materials.

Metal decks are limited by their deflection and need to be assessed for their pull-out resistance. Corroded and severely damaged panels need to be replaced.

Concrete decks that are wet need to have the possibility to dry out and deflections need to be corrected as per requirements.

Wooden and other degradable decks should always be examined for their condition (dryness) and pull-out resistance. Any wet or unsound portions must be replaced with new materials.

Repair deteriorated parapets

The substrate needs to provide structural integrity and adequate conditions to either fully adhere or mechanically fasten flashing membranes.

Replace or upgrade insulation

Wet or degraded boards need to be replaced. It may be necessary to upgrade or replace existing insulation with a complete new insulation system. If the existing roofing system remains, check its thermal performance (thickness required to avoid condensation issues) and the quality of attachment of the existing package to the deck.

Verify attachment of existing roof

On re-roofing projects, careful consideration should be given to evaluate the quality of attachment of the existing roofing system (inter-ply adhesion), in particular when the new membrane will be fully adhered directly onto the existing membrane.

Verify need for overlayment

Installation of UltraPly™ TPO membranes over concrete decks in a ballasted roofing system requires the application of a geotextile between membrane and concrete substrate.

Installation of UltraPly™ TPO membranes over cover boards in fully adhered roofing systems is only allowed when the boards are mechanically fastened with plastic sleeves or foam adhesive.

As previously explained, some substrates are not appropriate for direct application of the UltraPly™ TPO membrane and require the installation of a separation layer or adequate overlayment. Refer to the following section for specific information on cover boards.

On re-roofing projects, the surface condition of the existing roofing membrane (in case it is left in position) will determine the need for a separation layer. The existing roofing membrane must be basically sound, rot-free, not saturated with water and - in case of a fully adhered membrane - provide sufficient inter-ply adherence with the underlaying roof system.

The table below provides the most common re-roofing applications specific requirements for installation of a separation layer.

SUBSTRATE	ULTRAPLY™ TPO ROOFING SYSTEM			
	MECHANICALLY FASTENED	INDUCTION WELDED	FULLY ADHERED	BALLASTED INVERTED
BITUMINOUS MEMBRANE (SMOOTH)	1	1 / 4	2	1
BITUMINOUS MEMBRANE (CHIPPINGS)	3	3 / 4	4	3
BITUMINOUS MEMBRANE (GRAVEL)	4	4	4	4
SINGLE PLY (EPDM, TPO)	1	1	4	3
SINGLE PLY (PVC)	3 / 4	3 / 4	4	3

Notes:

1. Direct application when substrate meets general substrate requirements.
2. Direct application when inter-ply adhesion of existing roofing system is adequate. Testing of new adhered roofing membrane is required to assess peel strength.
3. Substrate requires installation of a geotextile (polyester fleece min. 200 gr/m²)
4. Substrate requires installation of an approved cover board or thermal insulation.

Bituminous flashings need to be stripped off if inter-ply adhesion is not adequate and new flashings are fully adhered.

Table 1.3 – Requirements for overlayment

Adjust flashing heights

Flashing heights may be limited. Existing building details (i.e. access doors, windows, roof penetrations) may not allow for sufficient clearance to provide proper termination (min. 150 mm) above the potential water level. Detailed consideration of this condition is critical to the integrity of the new roofing system. Rooftop equipment needs to eventually be remounted.

Correct poor drainage

The new roofing system can be used to correct poor drainage of the existing system by correcting errors of slope or installation of additional drains, as previously outlined.

Consider membrane protection

In some situations, the new roofing membrane has to be protected either by using river-washed gravel ballast, concrete pavers or by installing a walkway pad system. Installation of a sacrificial layer of membrane may be considered around technical equipment that generate heat.

Consider installation of a green roof or photovoltaic equipment. This can be done when structural conditions of the existing roof are sufficient.



1.3.3 Cover boards



Picture 1.38



Picture 1.39



Picture 1.40

Function

Cover boards are commonly used in re-roofing projects to improve the walkability of the roofing surface, cover joints between insulation boards and to provide a smooth and even separation layer between the existing and new roofing membrane. When used in this application they are often referred to as 'recovery board'.

Cover boards are also installed over the primary thermal insulation to provide enhanced physical properties such as improved fire resistance, higher compressive strength, prevention of de-lamination of facers due to traffic and improved wind uplift resistance.

In addition, cover boards help to avoid compatibility problems and protect the UltraPly™ TPO membrane and some insulations from direct contact with solvent-based adhesives or fresh bitumen.

Finally, they can also be used as an underlayment directly over steel decks to provide a thermal barrier (fire protection from inside) or a smooth surface for installation of a vapor control layer.

Firestone cover boards

Refer to Table 1.4 for the main characteristics of Firestone products that can be used.



TYPE OF COVER BOARD	DESCRIPTION	CHARACTERISTICS
 <p><i>Picture 1.41 - ISOGARD™ HD</i></p>	<p>Firestone ISOGARD™ HD is high density, closed cell, Polyisocyanurate foam core with a coated fiberglass facer.</p>	<ul style="list-style-type: none"> • Thickness 12.7 mm • Dimensions 1.22 m x 2.25 m • Reaction to fire (Euroclass) E • Compressive stress (10 % deformation) \geq 800 Pa • Water absorption \leq 3% • Suitable for fully adhered and mechanically fastened systems • Lightweight board, easy to cut and handle
 <p><i>Picture 1.42 - DENSDECK® PRIME</i></p>	<p>DensDeck® Prime is a non-structural gypsum core board with a primed fiberglass mat facer</p>	<ul style="list-style-type: none"> • Thickness 6.4 - 12.7 - 15.9 mm • Dimensions 1.22 m x 2.25 m • Excellent fire resistance (UL-Ratings) • Compressive stress (10% deformation) 900 Pa • Performs well under normal construction and maintenance foot traffic • Easy to cut and install • Suitable for fully adhered and mechanically fastened systems

Table 1.4 - Firestone cover boards

Alternative cover boards

Consult a Firestone technician or contact Firestone's technical department for approval of an alternative board that is not listed in Table 1.5.

Refer to Table 1.5 for the main characteristics of some alternative boards.

TYPE OF COVER BOARD	DESCRIPTION	CHARACTERISTICS
 <p><i>Picture 1.43 - GYPSUM BOARD</i></p>	<p>Non-structural board made of gypsum with a fiberglass mat facer. These boards are preferably pre-primed.</p>	<ul style="list-style-type: none"> • Thickness 12.7 - 15.9 mm • Excellent fire resistance (UL-Ratings) • Good impact resistance, performs well under normal construction and maintenance foot traffic • Uniform composition that gives the board strength and water resistance through the core • Excellent bond strength
 <p><i>Picture 1.44 - OSB - PLYWOOD</i></p>	<p>Oriented strand board (OSB) is a board composed of several layers of wood flakes (strands) of a pre-determined shape and thickness, which are connected with a binder. Plywood is a board made of thin layers or plies of wood veneer that are glued together. Adjacent layers have their wood grain rotated up to 90 degrees to one another.</p>	<ul style="list-style-type: none"> • Only OSB/3 and OSB/4 boards and exterior grade plywood boards are accepted • Minimum thickness of 12.7 mm • Suitable for mechanically fastened and fully adhered applications • Limitations with regards to fire resistance

Table 1.5 - Alternative cover boards

1.4 Thermal design



Picture 1.45



Picture 1.46



Picture 1.47

It is the responsibility of the specifier to determine the thermal performance of the roofing system and to verify if standards established by local codes have been met. Since thermal insulation requirements vary from country to country (insulation level, fire regulations, etc.), the designer and contractor should always refer first to national codes and regulations for recommendations.

Installation of one or more layers of thermal insulation on the roof deck is the most practical method to achieve the required thermal performance.

In addition, the application of a white and highly reflective UltraPly™ TPO membrane will help reduce the heat load on the roof and result in a moderating effect on the roof temperature, particularly on poorly insulated roofs.

In this section, the designer will find the criteria to select the most appropriate insulation material in function of its properties and application. We provide information about Firestone PIR insulation and outline the method to calculate the required insulation thickness.

As a vapor control is an integrated part of thermal design, we begin this section with information of the Firestone vapor control layers and basic guidelines for their installation.

1.4.1 Vapor control



Picture 1.48

Vapor control layers are often not required as a standard component of a single-ply roofing system when the roof build-up results in a natural transfer of water vapor into the roof assembly during one part of the year, followed by a natural drying process during the remainder of the year.

Under these conditions there is a cyclical water vapor flow into and out the roof that does not cause deterioration of the system, neither a reduction in its thermal performance.

In some buildings, however, there is a significant difference in vapor pressure between interior and exterior. As a result, the volume of water vapor transfer is much bigger and control of this flow into and through the roof requires specific attention. Insulation can become saturated with water and result in a significant reduction in thermal performance. Roof decks and fasteners can also be structurally affected and dripping of condensation may occur into the building.

It is the responsibility of the designer to determine the need for a vapor control layer, as well as its type, installation and location within the roof assembly. Since the requirements and climatic conditions vary from country to country, the designer should refer to local codes for recommendations on vapor control layers.

Vapor control layers are usually installed as close as possible to the “warm side” of the roof assembly; i.e. directly on the roof deck beneath the insulation. Enough insulation must be installed over the vapor control layer to raise the location of the dew point temperature (temperature at which condensation begins to form) above the level of the vapor control layer.

On re-roofing projects, the vapor transmission value of the existing roofing membrane also needs to be considered during calculation.

Conditions that require vapor control

The need for a vapor control layer should be investigated if any of the following conditions exist:

- Roofs exposed to average winter temperatures below 5°C and with a relative humidity inside $\geq 45\%$
- Buildings with high internal humidity such as swimming pools, textile mills, paper mills, food and other wet process industrial plants. These buildings have continuously temperatures above 20°C and R.H. of min. 70%.
- Buildings with construction elements that release moisture after installation of the roof, such as interior concrete, masonry, cementitious screeds, plaster finishing, fuel burning heaters, etc.
- Cold storage buildings and freezers. Internal vapor pressures within these buildings will always be lower than external vapor pressures. The roofing membrane must therefore have vapor resistance properties to avoid migration of warm and humid air into the roofing system.

Observation: At lower temperatures, condensation may occur at the backside of the membrane due to a combination of high transmission value μ and white color. This phenomenon is normal and has no impact on the performance of the roofing system.

Firestone vapor control membranes

Refer to Table 1.6 and the technical data sheet for the water vapor transmission value of Firestone V-Gard™ and Firestone UltraPly™ TPO membranes.

TYPE OF MEMBRANE	VAPOR TRANSMISSION $\mu \times t$ (m)
FIRESTONE V-GARD™	> 1500
ULTRAPLY™ TPO (1.1 mm)	220
ULTRAPLY™ TPO (1.2 mm)	240
ULTRAPLY™ TPO (1.5 mm)	300
ULTRAPLY™ TPO (1.8 mm)	360

Table 1.6 – Vapor transmission values of Firestone membranes

UltraPly™ TPO membranes have vapor resistance values that are significantly better than most bituminous or PVC membranes and are applied as an efficient vapor barrier at the external side of cold storage buildings.

Alternative vapor control layers

Alternative vapor control layers can be applied, provided they are compatible with Firestone UltraPly™ TPO roofing products. Depending on the requirements, one of the following products can be selected:

- Polyethylene film (thickness of 0.2 - 0.4 mm)
- Bituminous felt with glass fiber or polyester
- Bituminous felt with aluminium reinforcement
- Thermoplastic synthetic membrane (TPO)

Considerations for installation

Decks containing large amounts of construction water (in-situ concrete, screeds) should be adequately cured and dry before the installation of the vapor control layer. Drying out will be restricted by the presence of a vapor control layer. Drainage holes will eventually have to be drilled at the underside of the deck to facilitate drying.

Installation of a vapor control layer on metal decks with a roofing system that is mechanically fastened to the deck requires some specific attention. Air leakage at perimeter and penetrations may significantly reduce the effectiveness of the vapor control layer. Humid air that penetrates into the roof system can condensate. An effective vapor control system must therefore be completely sealed at perimeter and roof penetrations.

Refer to local codes for specific instructions with regards to installation (i.e. flashing height against upstands and roof penetrations, sealing methods at drains, etc.)



1.4.2 Thermal insulation



Picture 1.49

Thermal insulation is primarily used to reduce heat loss in colder climates and energy to cool buildings during hot summer days. It is also used in combination with an appropriate vapor control layer to limit and control production of internal condensation.

In addition, thermal insulation boards have to offer also other functions that are not less important. An appropriate insulation board needs to provide a stable and compatible substrate for a secure installation of the membrane. When properly attached, it will minimize stresses to the membrane and provide a firm substrate for welding. Each insulation material to be used within the UltraPly™ TPO roofing system therefore needs to offer adequate mechanical properties.

In addition the type of insulation will also have a significant impact on the fire performance of the roof.

Due to the many types of insulation available in the market and due to continuous changes and new developments, it is not possible to provide a complete list of all insulation products that can be applied in the Firestone UltraPly™ TPO systems. We therefore start with a summary of the most important technical requirements and characteristics that need to be taken into consideration when selecting an insulation material.

Following a brief description of the main characteristics of Firestone PIR insulation we present a general overview of the most commonly used types of insulation, including their common values for thermal conductivity and compressive strength.

We end this section with some general guidelines of applicability of the different types of insulation in the Firestone UltraPly™ TPO roofing systems.

Contact Firestone's technical department in case more detailed or specific information is needed.

The criteria listed on the next page can be used to select an insulation product that is appropriate for use within the different Firestone UltraPly™ TPO roofing systems. Each product needs to meet with several of the requirements outlined below.

Insulating efficiency

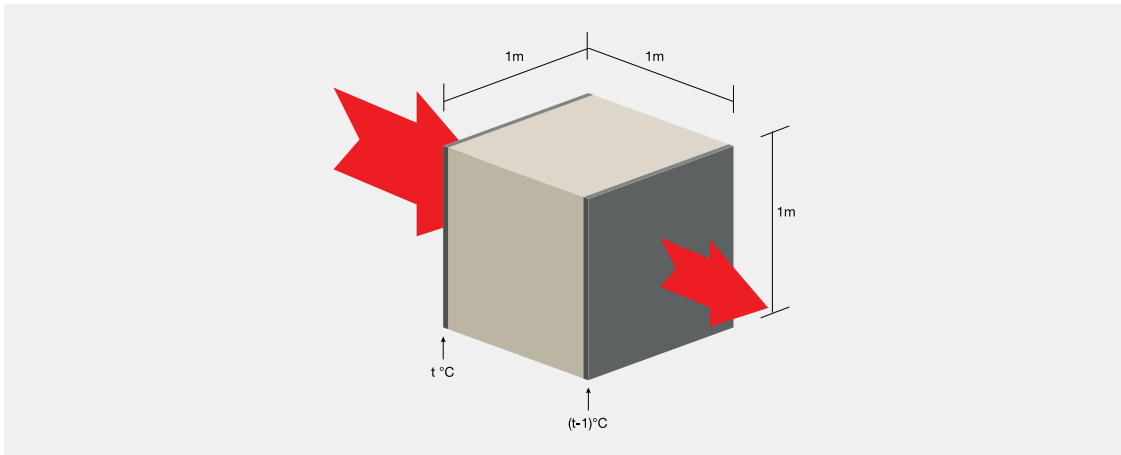

Figure 1.3 - Heat flow through insulation material

The lambda value (or λ – value), also referred to as ‘thermal conductivity’, is an indication to what extent a material conducts heat or, in other words, how efficient this material insulates. It indicates the quantity of heat (Watt) that is conducted through 1 m² of material, with a thickness of 1 m, when the difference of temperature between the opposite surfaces of the material equals 1°C.

Lambda values are expressed in W/mK. The lower the lambda value, the better the material insulates. Refer to Table 1.8 for the $\lambda(d)$ value of Firestone PIR insulation and to Table 1.10 for $\lambda(d)$ values (minimum and maximum) of alternative insulation products commonly used in Firestone UltraPly™ TPO roofing systems.

Walkability

Thermal insulation products need to be designed to absorb the traffic and loading that is expected during installation and service life of the roof without being damaged. This occurs in particular on roofs that require maintenance (airco units, photovoltaic equipment, ...). In function of the frequency and type of loading there will be different requirements for insulation and method of attachment (type of fastener, fastening plate, etc.).

The insulation must provide sufficient compressive strength, sufficient resistance against point loads and needs to be capable to distribute uniform loading without problems. On steel decks insulation boards with good resistance to point loads are critical since the boards are not fully supported.

Consult local codes for performance requirements of insulation products in function of type of loading.

Special consideration should be given to the long-term resilience of the board, so that it remains capable of withstanding intensive roof traffic. Some compressive boards, such as mineral fiber boards, are less resistant to traffic and loading. Only high-density MW boards (class C) are acceptable when providing sufficient resistance to dynamic loading.

Thickness

The thickness of the insulation board as defined by thermal calculation of the roof system (refer to section 3.3) is the minimum thickness required for fully supported boards. This thickness may need some adjustment when installing over steel decks in function of the span between the flutes (b). Consult the insulation manufacturer for maximum flute span of their products and minimum required thickness in case of overhang (o).

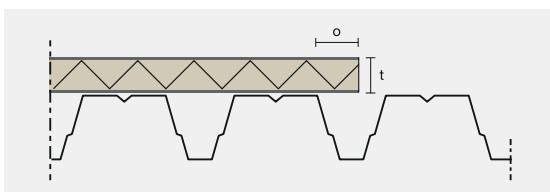

Figure 1.4 - Critical thickness insulation at overhang

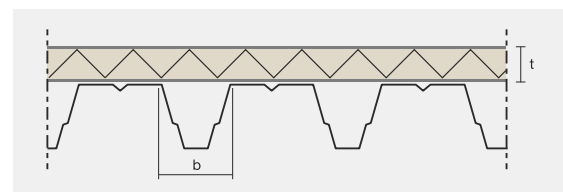

Figure 1.5 - Critical thickness insulation between flutes

Fire resistance

The resistance of the roofing system to external fire is to a significant extent influenced by the type of material installed directly underneath the roofing membrane. Some insulation products (MW, PIR) allow direct installation of the membrane. Other products (EPS, XPS) require installation of an overlayment to meet with local fire codes.

Compatibility of insulation

The compatibility of the insulation material is mainly important in case of fully adhered applications. Polystyrene boards (EPS, XPS) should not come into contact with solvent-based adhesives and cleaning products. The solvents used in contact adhesives are aggressive to polystyrene. Firestone recommends the installation of a recovery board in case of fully adhered applications over polystyrene boards.

Compatibility of finishing top facer

Some insulation boards provide a finishing surface or facer that is not suitable for direct application of a fully adhered or an induction welded Firestone UltraPly™ TPO roofing system.

Mineral wool, wood fiber and cellular glass insulation boards are not suitable for direct bonding of a UltraPly™ TPO membrane as they do not provide sufficient adhesion between the membrane and the top finishing. New developments resulted in mineral wool boards with a specific facer that is suitable for application of a fully adhered UltraPly™ TPO system. Contact Firestone's technical department for more specific information.

In general, PIR and PUR boards offer the best conditions for application of Firestone UltraPly™ TPO fully adhered roofing systems, provided they offer a suitable facer. Since there is always a difference in performance between top and bottom facer, Firestone recommends to follow the instructions of the supplier regarding the correct installation method of the insulation in fully adhered applications.

Insulation boards with alu-kraft facers are not suitable for the application of induction weld systems.

Consult Table 1.7 for information regarding the compatibility between facer and roofing system or contact Firestone's technical department in case of doubt.

TYPE OF FACER	ULTRAPLY™ TPO ROOFING SYSTEM			
	MECHANICALLY FASTENED	INDUCTION WELDED	FULLY ADHERED	BALLASTED INVERTED
MINERAL FIBER	A	A	A	A
BITUMINOUS IMPREGNATED FELT	A	!	NA	A
KRAFT	A	A	A	A
ALU-KRAFT	A	!	A	A
ALU-FOIL	A	NA	NA	A

A: Applicable
NA: Not Applicable

 Check possibility with Firestone's technical department

Table 1.7 - Applicability facer

Dimensional stability

Some insulation boards, in particular PIR and PUR, may warp after installation. Therefore, each insulation board always requires a minimum density of fixations to assure its dimensional stability, independent from the number of fixations required by wind uplift calculations. Refer systematically to the instructions of the manufacturer.

Firestone PIR insulation



Picture 1.50

Firestone PIR insulation boards consist of a closed-cell polyiso foam core laminated on both sides to a gastight multi-layered aluminium complex facer. Firestone PIR boards are suitable for use on mechanically fastened, fully adhered and ballasted UltraPly™ TPO roofing systems.

Foam and facer have been designed for optimum adhesion in case of a fully adhered membrane application. Boards are marked with "This side down" to indicate the optimum board application.

Refer to Table 1.8 for some basic characteristics of Firestone PIR insulation.

PROPERTIES	RESULT
λ - Value (W/m.K)	0.023
Compressive strength (kPa)	≥ 150
Fire Classification	FM Class 1 Approved Reaction to fire : B-s2
Facer	Multi-layered aluminium
Applicability	All methods of membrane attachment
Environmental Friendly	Global Warming Potential (GWP) < 5, no CFC
Thicknesses (mm)	Ranging from 30 to 140
Dimensions (mm x mm)	600 x 1200 ; 1200 x 1200 ; 1200 x 2400
Finishing	Flat boards with straight edges

Table 1.8 – Characteristics Firestone PIR insulation

Firestone PIR boards are designed to be applied on different steel deck profiles. Refer to table 1.9 for the minimum thickness of Firestone PIR insulation in function of the type of steel deck.

TYPE OF STEEL DECK	FLUTE SPAN (mm)	MINIMUM THICKNESS FIRESTONE PIR (mm)
42/1010	73	30
73/780	70	30
106/750	110	30
158/750	131	50
153/840	161	50
135/930	165	50

Table 1.9 - Critical thickness PIR in function of steel deck

Overhang of Firestone PIR insulation boards is only allowed for boards with thickness (d) > 50 mm - max 110 mm (o).

Alternative insulation boards

UltraPly™ TPO membranes can be applied on insulation boards that are not manufactured by Firestone.

Refer to Table 1.10 for an overview of the minimum requirements for λ -values and compressive strength when selecting an appropriate alternative insulation product.







THERMAL INSULATION			PROPERTIES		
TYPE OF INSULATION	NAME	CODE	THERMAL CONDUCTIVITY λ (W/m.K)	VOLUMIC MASS (kg/m ³)	COMPRESSIVE STRENGTH (kN/m ²)
	EXPANDED POLYSTYRENE	EPS	0.031-0.045	20	100 (10% compression)
	EXTRUDED POLYSTYRENE	XPS	0.028-0.038	33	300
	POLYURETHANE	PUR	0.023-0.029	30	150 (10% compression)
	POLYISOCYANURATE	PIR	0.023-0.029	30	150 (10% compression)
	MINERAL WOOL (ROCK FIBER)*	MW	0.031-0.044	165-200	UEATC - class C
	CELLULAR GLASS	CG	0.036-0.050	115	500-1600
	WOOD FIBER	WF	0.035-0.055	40	110

Table 1.10 - λ (d) – values and minimum requirements compressive strength of most commonly applied insulation products.

* : Mineral wool boards made of glass fiber don't have sufficient compressive strength to be applied on flat roofs

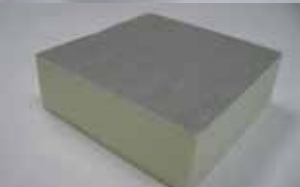
Applicability alternative insulation boards

The $\lambda(d)$ values in Table 1.10 are declared by the supplier and are measured based on the NBN EN procedure or an ETA technical approval. The λ -values used in calculations are determined based on these declared values, taking into consideration conditions of application (inside, outside) and exposure (temperature, humidity, etc.)

Consult Firestone's technical department for approval in case the product to be used does not meet the technical requirements outlined in Table 1.10.

Refer to Table 1.11 for general guidelines regarding the applicability of an alternative insulation board in UltraPly™ TPO roofing systems.

THERMAL INSULATION		ULTRAPLY™ TPO ROOFING SYSTEM				
INSULATION	ABBREVIATION	MECHANICALLY FASTENED	INDUCTION WELDED	FULLY ADHERED	BALLASTED	INVERTED
EXPANDED POLYSTYRENE	EPS	1(5)	1(7)	4	1	NA
EXTRUDED POLYSTYRENE	XPS	1(5)	1(7)	4	1	1
POLYURETHANE	PUR	1(5)	1(3)	1(2)	1	NA
POLYISOCYANURATE	PIR	1	1(3)	1(2)	1	NA
MINERAL WOOL (rock fiber)	MW (RF)	1	1(8)	4	1	NA
CELLULAR GLASS	CG	NA	NA	4	6	NA
WOOD FIBER	WF	1(5)	1	4	1	NA

Specific requirements for installation:

1. Direct application
2. Suitable facer for adhesion - acceptable facers are glass fiber, kraft and alu-kraft
3. Suitable facer for induction welding - acceptable facers are glass fiber, kraft and alu-kraft
4. Overlayment suitable for adhesion
5. Overlayment suitable for fire protection
6. Separation layer (min. geotextile of 200 gr/m²)
7. Installation of cardboard discs under TPO induction welding plates to avoid melting of insulation
8. Use of plastic sleeves in combination with TPO induction welding plates

NA = Not applicable

Table 1.11 - Applicability alternative insulation materials



1.4.3 Calculation and design

The information in this section is merely to understand the calculation method applied during design of a thermal insulation. We will define the thickness of the insulation of a simple roof on a metal deck, also to illustrate that the thermal resistance of any roofing system installed over this type of roof deck is mainly defined by the performance of its insulation layer(s).

The selection of the insulation material and the calculation of its thickness does not only depend on the specific requirements of the project but also on local codes. The specifier and roofing contractor must therefore always refer to these codes.

Since all codes and requirements systematically refer to U-values and R-values, we will first start by explaining these values.

Definition basic values

U-Value

The U-value expresses the transport of thermal energy through a structure and represents the flow of heat (in Watt) passing through 1 m² of that structure, when the difference between the two surrounding temperatures is 1°C.

U is called thermal transmission coefficient and is expressed in W/m²K. The lower this coefficient, the better the structure insulates.

U-values are established by local codes and apply to the total assembly of a building element (i.e. roofing system).

The U-value (or thermal performance) of a roof build-up can be calculated using the following formula:

$$U \text{ (W/m}^2\text{K)} = \frac{1}{R \text{ (tot)}}$$

U-value is the reciprocal of the R-value.

R-Value

The R-value or 'thermal resistance' is a measure used in construction to indicate the insulating value of a material (roof deck, insulation, membrane, etc.) or a layer (i.e. air). It depends on the thickness (t) of the material/layer (expressed in m) and its thermal conductivity or λ (W/Km).

$$R = t / \lambda$$

R-values are expressed in m²K/W.

A higher R-value represents a better insulation. This can be achieved in two ways, either by using a material with a low λ -value or by increasing the thickness of the material.

R(tot)-value

The R(tot)-value of a roof build-up is the sum of the R-values of all individual components and layers.

The R(tot)-value can be calculated using the following formula:

$$R(\text{tot}) = R_{\text{si}} + \sum R_i + R_{\text{se}} \text{ (m}^2\text{K/W)}$$

In this formula, we identify the following values:

- R(tot) = Total heat resistance of roof build-up, expressed in m²K/W
- R_{si} = Heat resistance of inside air layer at the roof ceiling (0.10 m²K/W)
- R_{se} = Heat resistance of external air layer at membrane surface (0.04 m²K/W)
- R_i = Sum of all resistances of different components roof build-up (m²K/W)

Calculation

In our example, we design a roof assembly to meet with a standard U-value of 0.30 W/m²K.

Refer to Figure 1.6 for specific details of the roof build-up and to Table 1.12 for information regarding the characteristics (thicknesses and insulating properties) of the different layers.

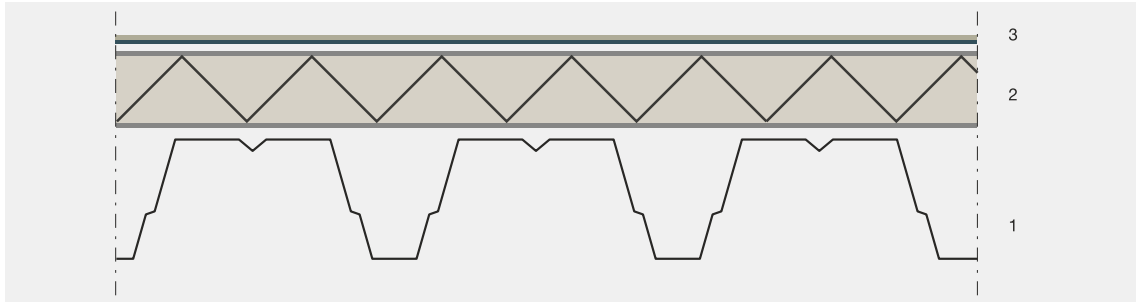

Figure 1.6 - Roof build-up - Thermal design | 1-Steel deck | 2-PIR insulation | 3-TPO membrane

LAYER	PROPERTIES		
	THERMAL CONDUCTIVITY λ (W/m.K)	THICKNESS T (m)	THERMAL RESISTANCE (m ² .K/W)
EXTERNAL AIR	-	-	0.04 (R _{se})
TPO MEMBRANE	0.17	0.0015	0.0088
PIR INSULATION	0.023	t	R ₃
STEEL DECK	58	0.00075	0.000012
INTERNAL AIR	-	-	0.10(R _{si})

Table 1.12 - Characteristics of roof layers

The calculation method is explained in detail in Table 1.13.

DESCRIPTION INDIVIDUAL STEPS	VALUE EXAMPLE
1. DETERMINE U-VALUE	REFER TO NATIONAL STANDARDS AND CODES U = 0.30 W/m ² K
2. CALCULATE R1 (required thermal resistance)	R1 = INVERSE OF U-VALUE R1 = 3.33 m ² K/W
3. CALCULATE R2 (sum of all thermal resistances of roof without insulation)	R2 = SUM OF ALL THERMAL RESISTANCES OF THE ROOF EXCLUDING THERMAL INSULATION R2 = 0.1488 m ² K/W
4. CALCULATE R3 (thermal resistance required for thermal insulation)	R3 = THERMAL RESISTANCE NEEDED TO ACHIEVE THE U-VALUE - R3 = R1 - R2 R3 = 3.1812 m ² K/W
5. DEFINE t (thickness insulation)	t = R3 x λ t = 0.073 m

Table 1.13 – Calculation steps

RESULT: In this situation, a layer of PIR insulation with a thickness of minimum 75 mm is required to achieve a U-value of 0.30 W/m²K.

It is important to observe that this calculation has been simplified, since the objective is to explain the basic method of design. Conditions that may reduce the thermal performance of the roof assembly were therefore not taken into consideration, including:

- poor installation of insulation boards
- cold bridging
- number of layers of insulation
- method of attachment (mechanical, adhesive)
- type of fastening system (plastic, metal)

In practice, thermal calculations are made following the same method and correction factors are applied on the U-value that take into account the above-mentioned conditions.

Refer to local codes for more information.

Design principles

- Apply insulation boards with lowest λ -value
- When possible, install 2 layers of insulation (second layer staggered)
- Second layer should preferably be thicker
- Use plastic sleeves to fix the insulation to reduce cold bridging

1.5 System design



Picture 1.51



Picture 1.52



Picture 1.53



Picture 1.54

The information in this section serves to design a roofing system that meets with technical requirements and standards of fire resistance and wind uplift.

The designer will find criteria to select the UltraPly™ TPO membrane that is most suitable for his project.

In addition, he will find information about the fire performance of Firestone UltraPly™ TPO roofing systems and some general design considerations of wind design. Since the fire and wind uplift performance of a roofing system depend to a large extent on the way the roof components are connected, we outline in detail the different methods to attach insulation and membrane.

To simplify the design process, Firestone has identified the most frequently used UltraPly™ TPO roof assemblies with proven performance. These assemblies are presented in "selection-tables" at the end of this section and can be used as a starting point for design.

However the final design of the UltraPly™ TPO roofing system is the responsibility of the designer and roofing contractor who need to verify if the roof build-up meets with the standards established by local codes. Since requirements vary from country to country, they should always refer first to national codes and regulations.

Finally pay attention that codes vary and/or change continuously. Numerous combinations may appear possible but not all are technically acceptable.

1.5.1 Membrane selection



Picture 1.55

Firestone limits its offering to one type of membrane, based on a formulation that has been designed for global use in all climates. Since Firestone UltraPly™ TPO membranes can be installed using all methods of installation, this simplifies storage and avoid mistakes during logistics and installation.

UltraPly™ TPO membranes are reinforced with a polyester weft-inserted scrim and are available in different widths, thicknesses and colors. They are used to cover the roof and to flash upstands.

Unreinforced membranes are available in rolls of one width (600 mm) and one thickness (1.5 mm) and are used exclusively for detailing.

Panel size may vary in function of the selected system and building conditions. Refer to Table 1.14 for an overview of the product offering of UltraPly™ TPO membranes.

Panel size

DIMENSION	US SPECIFICATION				EU SPECIFICATION		
THICKNESS (mm)	1.1 - 1.5	1.1 - 1.5	1.1	1.1 - 1.5	1.2 - 1.5 - 1.8	1.2 - 1.5 - 1.8	1.2 - 1.5 - 1.8
PANEL WIDTH (m)	1.52	2.44	2.65	3.05	1.00	1.50	2.00

Table 1.14 – Panel sizes UltraPly™ TPO membranes

Panels with maximum width (3.05 m) are commonly used in ballasted, inverted, fully adhered and induction welded systems.

In case of mechanically fastened systems, the width of the UltraPly™ TPO membrane is subject to the required density of the fasteners and the spacing between the fastening plates (corrugation width of steel deck). Perimeter and corner areas usually require smaller panels than in the field.

The widths indicated on Table 1.14 have to be adjusted in function of site conditions such as type, number and spacing of roof obstructions. Smaller widths than the ones listed in the table can be achieved by cutting the panels in half.

Thickness

The following aspects need to be considered when defining the membrane thickness:

- Required technical performance (mechanical properties)
- Type and grade of exposure (traffic, etc.)
- Required service life of the roof
- Fire performance of roofing system
- Hail performance of roofing system

The total thickness of the membrane, and especially its thickness over scrim, has a direct effect on the ability of the membrane to provide resistance to long-term weathering. It also assures important mechanical properties such as puncture resistance, hail resistance and abrasion and has also a significant impact on its fire performance and weldability.

Refer to the Declaration of Performance (DoP) table in Chapter 6 for specific data of the properties of UltraPly™ TPO membranes with different thicknesses.

Thicker membrane means better membrane. Note that welding conditions need to be adjusted.

Color

UltraPly™ TPO membranes are available in light colors (white and light grey) and offer a high level of reflectivity. White UltraPly™ TPO membranes typically display reflectivity ratings in the high 80 percent range when new and in the low 60 percent range after a 3-year rooftop exposure. Refer to the table on Chapter 6 for specific reflectivity ratings.

UltraPly™ TPO membranes remain resistant to mold and algae growth over time, which can degrade the overall reflectivity of the roof. Aged reflectivity of UltraPly™ TPO membranes remains therefore high. A good roof slope is also important. If necessary, cleaning the membrane after years of exposure can be done easily. Refer to Chapter 3 for more details.



1.5.2 Fire performance



Picture 1.56

UltraPly™ TPO membranes are made fire resistant by adding fire retardant chemicals during the compounding process. These additives do not impact the weldability nor the ease of installation of the membrane.

When looking at fire behavior of roofing membranes, there are two relevant classifications:

Reaction to fire classification as per standard EN 13501-1 is based on testing in accordance with testing standard EN ISO 11925-2. Reaction to fire relates to the combustibility and ignitability of a material on its own. UltraPly™ TPO membranes obtain a reaction to fire classification "E" for all thicknesses (1.1 mm to 1.8 mm).

Resistance to external fire classification as per standard EN 13501-5 is based on testing in accordance with CEN technical specification CEN/TS EN 1187. Resistance to external fire relates to the ability of an entire roof build-up to stop external fire (i.e. coming from adjacent building) from penetrating the roof and/or spreading across its surface. To achieve a good resistance to external fire, other aspects have to be considered such as roof deck, vapor control layer, insulation, separation layers, method of attachment, slope, etc.

Roof build-ups with UltraPly™ TPO membranes of all thicknesses (1.1 mm to 1.8 mm) have been tested and have obtained:

- Broof (t1) ratings for all thicknesses installed on most commonly applied substrates and insulation materials (PIR, PUR, MW). Restrictions are to be made over EPS where only mechanically fastened membranes with a minimum thickness of 1.5 mm achieve a classification after installation of a separation layer of glass fleece. Direct installation on wooden decks requires the installation of a Firestone ISOGARD™ HD cover board.
- Broof (t3) ratings for all thicknesses installed over MW insulation and for a 1.8 mm thick membrane over PIR.

Contact Firestone's technical department for more detailed information about the approved insulation boards (type, thickness, density, facer, etc.), and specific buildups on different types of roof deck. EXAP reports are available for specific information of applications on MW, PIR, EPS and ISOGARD™ HD cover boards.

1.5.3 Wind design



Picture 1.57

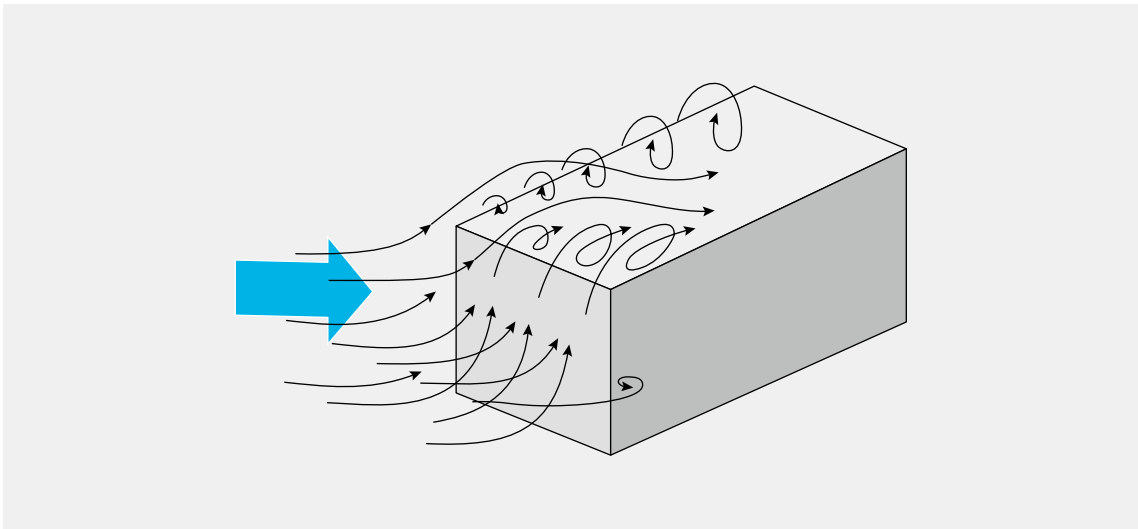

Figure 1.7 - Wind acting on flat roof

When wind strikes a building, it is deflected and accelerates around the building and over the roof, as illustrated. This results in a positive pressure on the windward side of the building and a negative (reduced) pressure in its trail. The most important pressures are therefore experienced at the windward corners, roof edges, ridges, roof steps and around penthouses, while the lowest pressures are usually measured in the central area of the roof. Damage caused to flat roofs therefore usually starts at windward corners and edges.

STEP 1 - Determine the actual wind pressures in the different areas of the roof

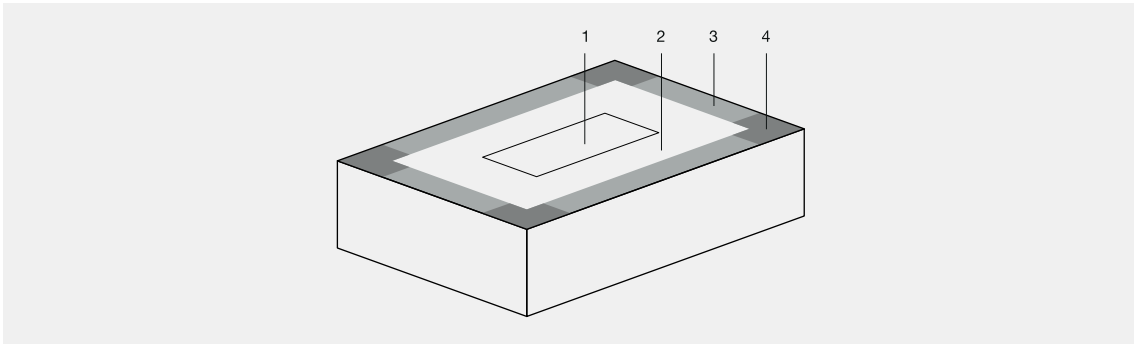

Figure 1.8 - Wind areas on standard flat roof - 1 - 2 = Center | 3 = Perimeter | 4 = Corner

Since wind codes and calculation methods differ from country to country, the specifier should refer to local building codes to estimate maximum wind loads and define the wind uplift pressures in the different areas of the roof.

The following aspects need hereby taken into consideration:

- Maximum wind speed to be expected (refer to wind maps)
- Building location (region, topography of surroundings, proximity of high buildings)
- Building dimensions (height, length, width)

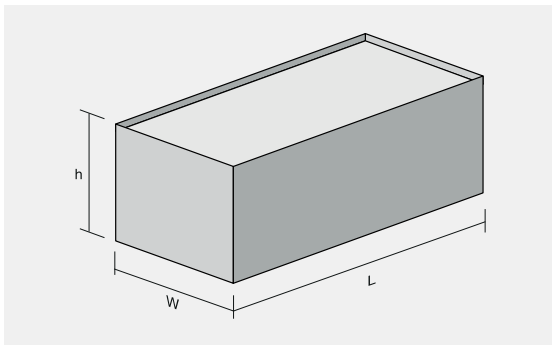

Figure 1.9 - Low building

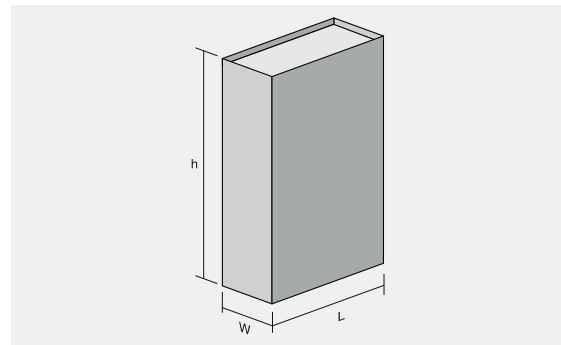

Figure 1.10 - High building

- Height of upstands
- Roof configuration (roof shape, slope, penthouse ...)
- Roof deck (air permeability)
- Buildings with positive pressure
- Wall openings (docks with large loading bays, hangar doors, etc.)

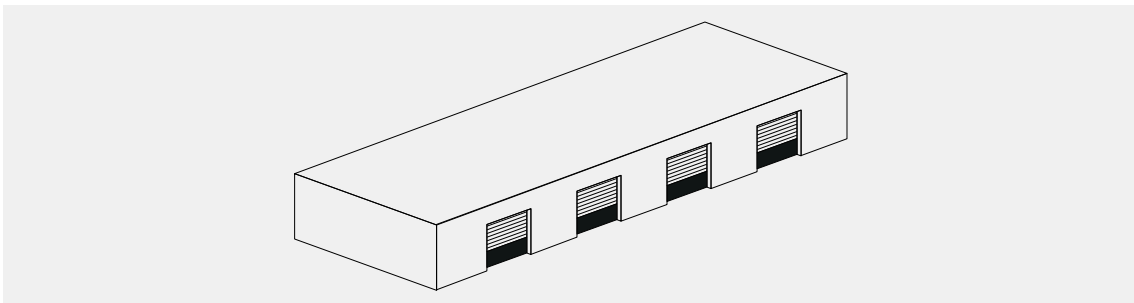

Figure 1.11 - Hangar with open doors

In roof constructions with air-permeable decks (decks with joints) such as metal and wooden decks, wind uplift forces may be increased by additional internal pressure when windows or doors on the windward side of the building are left open or wind penetrates through cladding around openings. In these situations, the installation of an air barrier may be required to stop air flowing into the roofing system.

STEP 2 - Designers should define secure methods of attachment for all layers above the deck, including vapor control layer, insulation (cover board) and membrane

Consider the following aspects:

- Conditions of roof deck (pull-out, load bearing capacity, structural integrity, compatibility for adhesion...)
- Performance of selected system of attachment
- Safety factors

It is important to know that numerous UltraPly™ TPO systems are tested and certified in accordance with FM Global (Factory Mutual), Eurocode and other standards. This information is available and can be used for design.

Contact Firestone's technical department for specific information regarding build-up, wind uplift performance and ratings of tested roofing systems.

STEP 3 - Pay specific attention to detailing, in particular regarding the design of wall flashings

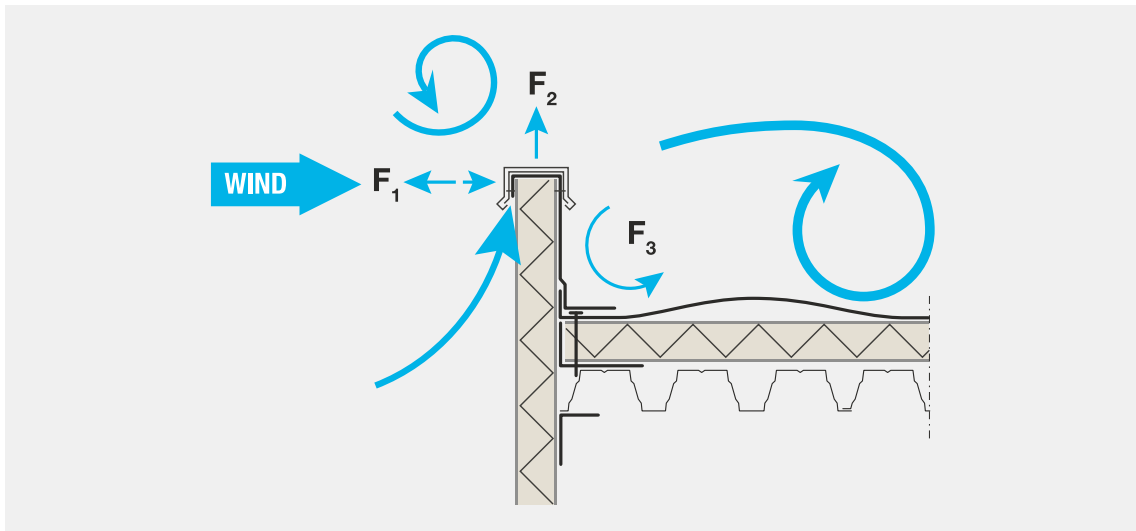

Figure 1.12 - Wind acting on roof edge detail

Consider the following aspects:

- Method to attach flashings (in preference fully adhered)
- Fixation of metal copings, edge profiles and scuppers
- Design of base tie-in details

1.5.4 Systems of attachment



Picture 1.58



Picture 1.59



Picture 1.60



Picture 1.61

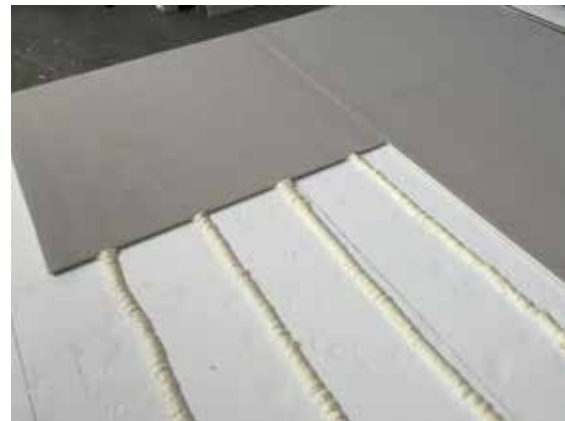

Picture 1.62

It is essential that attachment of all layers above the deck, including vapor control layer, insulation, cover board and membrane is secure, fast and efficient.

Systems of attachment are subjected to a wide range of static, dynamic and thermal stresses. A correct design is important to ensure the minimum required wind uplift performance of the roofing system.

In function of the requirements of his project (required wind uplift performance, possibility for mechanical attachment, vapor control, aesthetics, etc.) the designer can consider one of the following solutions:

- a system where insulation/cover board and membrane are mechanically anchored to the deck
- a non-perforating system where insulation/cover board and membrane are bonded to the deck
- a hybrid system where the insulation/cover board is mechanically fastened and the membrane is fully bonded

The information in this section may assist in selecting the appropriate products and method of attachment.

Mechanical fastening systems

The designer/installer should take into consideration following conditions to select the appropriate fastener:

- Type, quality and properties of the roof deck
- Required performance (pull-out)
- Compatibility with fastening plate, sleeve or bar (pull through)
- Ease and speed of installation
- Site conditions (atmosphere, high humidity)
- Expected service life

In function of the above criteria, the selected fastener should be compatible with the substrate (drilling point, size, thread), with the installation equipment (head), with the installation conditions and with the design life of the roofing system (type of material). On steel decks, fasteners are usually self-tapping screws made of carbon-hardened steel (coated or with zinc protection) and with a minimum diameter of 4.8 mm. Point and thread are to be adapted to the thickness of the steel.

Firestone fasteners

Firestone All Purpose (AP) and Heavy Duty (HD) fasteners are commonly applied on steel and wooden substrates. HD fasteners can also be applied on concrete decks. Firestone AP fasteners can be substituted by Firestone HD fasteners for any roofing system requiring a superior performance.



TYPE OF FASTENER	SIZE (Ø - mm)	SUBSTRATE					
		Steel 0.63 mm (upstands)	Steel 0.70 mm	Steel 0.75 mm	Steel 1.0 mm	OSB 18 mm (Euro 3)	Concrete C25
 <p>Picture 1.63 All Purpose fastener</p>	6.1	1200	1600	1800	1800	2000	NA
 <p>Picture 1.64 Heavy Duty fastener</p>	6.7	1800	2400	2700	2700	-	3500

Table 1.15 – Indicative pull-out values Firestone fasteners

Refer to Table 1.15 for indicative pull-out values of Firestone fasteners. Note that these values are mean values measured during testing. Design values should be calculated from these characteristic values after applying correction factors that take into account the characteristics of the substrate and type of application (type of plate, metal bar, etc.).

Firestone plates and bars

Firestone plates and bars are compatible with Firestone All Purpose (AP) and Heavy Duty (HD) fasteners and can be used on any substrate.

Firestone insulation fastening plates can be used to attach insulation boards and cover boards. Firestone barbed seam plates are used to attach UltraPly™ TPO membranes. Firestone metal bars are an alternative to secure Firestone membranes at all locations where a linear attachment is appropriate (i.e. base tie-in, top of wall flashings, ...)

TPO induction welding plates are available for the induction welded system and this in combination with plastic sleeves for installation over thicker insulation and boards with lesser compressive strength.

Refer to Table 1.16 to select the appropriate fastening plate or bar.





TYPE OF FASTENING DEVICE	DESCRIPTION FASTENING DEVICE	Minimum dimensions (mm)	APPLICATION CONDITIONS
SECUREMENT INSULATION AND COVER BOARDS			
 Picture 1.65	Firestone insulation fastening plate. Round stress plate with profile. Plates are made of galvanized steel.	Ø (75)	Attachment of all type of insulation and cover boards. The plate is designed to avoid contact between fastener head and membrane. Compatible with Firestone AP and HD fasteners.
SECUREMENT TPO MEMBRANE			
 Picture 1.66	Firestone barbed HD seam plate. Round stress plate with profile and teeth. Plates are made of galvanized steel.	Ø (50)	Attachment of Firestone UltraPly™ TPO membranes.
 Picture 1.67	Firestone TPO induction welding fastening plate.	Ø (70)	Attachment of membrane and insulation boards in induction welded system.
 Picture 1.68	Flat metal batten bar of galvanized steel.	25	Attachment of Firestone UltraPly™ TPO membranes, in particular at base tie-ins and top of upstands.

Table 1.16 - Applicability Firestone fastening plates and bars

Alternative fastening systems

Alternative fasteners and/or plates can be applied, in particular on concrete and critical decks (aluminium, thin metal sheets (<0.63 mm), SW panels, etc.), provided the supplier is a manufacturer approved by Firestone and the selected fastening system provides the required minimum pull-out value.

Fastening plates and sleeves serve to transfer the stresses to which insulation and membrane are exposed to the fasteners. The shape of the plates and sleeves need to be compatible with the selected fastener and need to be adapted to the compressibility of the insulation.

In case insulation boards with lesser compressive strength are used, it is recommended to use fasteners with a high thread to assure a better anchoring of fastener and plate or to apply plastic sleeves. This avoids puncturing the membrane.

The use of plates with an indentation or a convex shape is recommended in case rigid insulation boards or boards with a more rigid facer (aluminium) are used. The underside of these plates must be flat.

Verify always the compatibility between the fastener and the fastening plate or sleeve.

Consult Table 1.17 for general guidance to select an appropriate fastener and contact the respective supplier for specific information with regards to his product (size, thread, head, coating, pull-out, etc.).

Consult a Firestone technician or contact Firestone's technical department for use of a type of fastener that is not mentioned in this table, for additional information about pull-out values or for applications on other substrates.











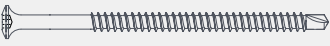

TYPE OF FASTENER	DESCRIPTION FASTENER	Min. Ø fastener (mm)	Ø Drill hole (mm)	Steel < 0.63 mm
	Case-hardened carbon steel screw with coating for corrosion protection. Standard hexagon head and self drilling point. High thread for applications on compressible insulation boards.	4.8	-	
	Case-hardened carbon steel screw with coating for corrosion protection. Standard hexagon head and self drilling point. Low thread for applications on hard insulation boards.	4.8	-	
	Case-hardened carbon steel screw with coating for corrosion protection. Countersunk head with Torx drive or cross recess and self drilling point.	4.8	-	
	Case-hardened carbon steel screw with coating for corrosion protection. Mushroom head with Torx drive or cross recess and self drilling point.	6.3	-	
	Case-hardened carbon steel screw with coating for corrosion protection. Countersunk head with Torx drive or cross recess. Fine pitch thread with fine self drilling point.	4.8	-	
	Case-hardened carbon steel screw with coating for corrosion protection. Countersunk head with Torx drive or cross recess. Fine pitch thread over complete length and fine self drilling point.	5.2	-	
	Case-hardened carbon steel concrete screw with coating for corrosion protection. Flat head with Torx drive or cross recess and no drilling point.	6.3	5.0	
	Case-hardened carbon steel concrete screw with coating for corrosion protection. Standard hexagon head and no drilling point.	6.3	5.0	
	Stainless steel spike fastener with mushroom head and no drilling point.	4.8(L<150) 6.3(L>150)	4.8(L<150) 6.3(L>150)	
	Stainless steel screw with flat head with Torx drive or cross recess and self drilling point. Special thread design for light weight concrete.	8	-	
	Peel rivet with the sleeve made from an aluminium/magnesium alloy. The center pin is made from a zinc coated carbon steel or stainless steel.	6.3	7.0	●
	Case-hardened carbon steel or stainless steel screw with carbon hardened steel or plastic plug.	6.3	6.3	
	Powder actuated shot firing pin.	Ø function of substrate	-	

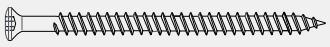
Table 1.17 (Figures 1.13-1 - 1.13-13) - Applicability alternative fastening systems | ● Recommended application | ● Pre-drilling required

	Steel 0.63 mm	Steel > 0.63 - 1.0 mm	Steel > 1.0 - 1.5 mm	In-Situ Concrete	L. weight Concrete	TT-slab	Hollow Concrete	Wooden decks	S.W Panel	Aluminium	Masonry	Structural Steel
		●	●					●				
		●	●					●				
		●	●					●				
	●	●	●									
	●							●				
								●				
				●		●	●					
				●		●	●					
				●								
					●							
									●	●		
						●	●				●	
												●



Alternative fastening plates and plastic sleeves can be applied, provided the supplier is a manufacturer approved by Firestone and the selected plate/sleeve is compatible with the selected fastener (size, head, thread), thickness and type of insulation and application conditions.

Fastening plates are made from alu-zinc coated steel (stress plates); sleeves are made from high-grade plastic material.



Approved plastics are Polypropylene, Polyethylene and Polyamide. Use of Polypropylene washers is not allowed in cold climates.

Take into consideration that plastic sleeves or plates with too important indentation (profile) that are installed within the seam may cause a deformation of the UltraPly™ TPO membrane and therefore create difficulties during welding.

TPO induction welding plates are available for the induction welded system and this in combination with plastic sleeves for installation over thicker insulation and boards with lesser compressive strength.

Consult Table 1.18 for general guidance to select an appropriate plate or sleeve. The shape of the plate depends on the required pull-through value of the fastener and the selected method of installation. Plates in elliptic shape are preferred for automatic installation while round plates are usually applied by hand. Contact the respective supplier for specific information with regards to the performance of his product.

In case of doubt, contact Firestone's technical department for use of plates or sleeves that are not mentioned in this table or for more specific information or for approval of an alternative system.

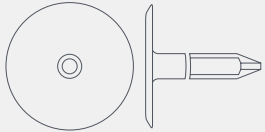
SECUREMENT INSULATION & COVER BOARDS			
TYPE OF PLATE / SLEEVE	DESCRIPTION FASTENING PLATE	MINIMUM DIMENSIONS (MM)	APPLICATION CONDITIONS
	Round stress plate with profile. Plates are made of case-hardened carbon steel with zinc coating or stainless steel.	Ø (70)	All type of insulation and cover boards. Hard boards or boards with a rigid facer (aluminium) require application of plates with a flat underside.
	Square flat stress plate with a big indentation (3.5 - 7 mm) in the center. Plates are made of case-hardened carbon steel with zinc coating or stainless steel.	65 x 65	Attachment of insulation boards with limited compressive strength. Less recommended to attach hard boards or boards with a rigid facer (aluminium).
	Round telescopic sleeve made of plastic.	Ø 75	Attachment of insulation boards with low compressibility, thicker insulation packages or insulation boards in roofing systems where thermal bridging needs to be eliminated.

SECUREMENT ULTRAPLY TPO MEMBRANE			
TYPE OF PLATE / SLEEVE	DESCRIPTION FASTENING PLATE	MINIMUM DIMENSIONS (MM)	APPLICATION CONDITIONS
	Flat stress plate in elliptic shape with small indentation (≤ 3.5 mm). Plates are made of case-hardened carbon steel with zinc coating or stainless steel.	40 x 80	Membrane attachment over all types of insulation boards, cover boards and hard substrates.
	Flat stress plate in elliptic shape with big indentation (3.5 - 7 mm). Plates are made of case-hardened carbon steel with zinc coating or stainless steel.	40 x 80	Membrane attachment over boards with limited compressive strength. Less recommended for membrane attachment over hard boards or boards with a rigid facer (aluminium).
	Convex stress plate in elliptic shape. Plates are made of case-hardened carbon steel with zinc coating or stainless steel.	40 x 80	Membrane attachment over all types of insulation boards, cover boards and hard substrates.
	Round flat stress plate with profile. Plates are made of case-hardened carbon steel with zinc coating or stainless steel.	40	Membrane attachment over all types of insulation boards, cover boards and hard substrates.
	Round telescopic sleeve made of plastic.	45	Membrane attachment over boards with low compressibility, over thicker insulation packages or in roofing systems where thermal bridging needs to be eliminated.
	Telescopic sleeve in elliptic shape made of plastic.	40 x 80	Membrane attachment over boards with low compressibility, over thicker insulation packages or in roofing systems where thermal bridging needs to be eliminated.
SECUREMENT INSULATION & ULTRAPLY TPO MEMBRANE (INDUCTION WELDING)			
TYPE OF PLATE / SLEEVE	DESCRIPTION	MINIMUM DIMENSIONS (MM)	APPLICATION CONDITIONS
	Round stress plate with profile. Plates are made of case-hardened carbon steel or stainless steel and the topside is coated with TPO for welding. Diameter of hole is 6.8 mm.	80	Attachment of all insulation and cover boards. Special attention is required in case of EPS boards (use of separation discs) and PIR or PUR boards with aluminium or aluminium kraft facer (compatibility of welding devices)
	Round stress plate with profile. Plates are made of case-hardened carbon steel or stainless steel and the topside is coated with TPO for welding. Diameter of hole is 16 mm for installation of plastic (telescopic) sleeve.	80	Attachment of thicker insulation package or insulation boards with limited compressive strength.

Table 1.18 (Figures 1.14-1 - 1.14-11) - Applicability alternative fastening plates

Fastener length

 <ul style="list-style-type: none"> • Steel deck using metal plates • Fastening length (L min) = $KL + 20\text{ mm}$ 	 <ul style="list-style-type: none"> • Steel deck using plastic sleeves • Fastening length (L min) = $KL + 20\text{ mm}$
 <ul style="list-style-type: none"> • In-situ concrete • Fastening length (L min) = $KL + Sd$ (min 20 mm) • Drill depth = $Sd + \text{min } 15\text{ mm}$ 	 <ul style="list-style-type: none"> • Lightweight concrete • Fastening length (L min) = $KL + Sd$ (60 mm)
 <ul style="list-style-type: none"> • Wooden decks • Fastening length (L min) = $KL + 30\text{ mm}$ 	 <ul style="list-style-type: none"> • Aluminium and/or thin metal sheets • Fastening length (L min) = $KL + 10\text{ mm}$
<ul style="list-style-type: none"> • KL = Thickness of total roof build-up between top surface of TPO membrane and the upper surface of roof deck • KL = Thicknesses of vapour barrier + thermal insulation + TPO membrane • Sd = Setting depth of fastener 	

Table 1.19 (Figures 1.15-1 - 1.15-6) - Schemes to determine fastener length

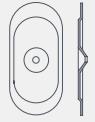
The length of the fastener depends on the type of substrate, thickness of the membrane (new and existing), thickness of the insulation and type of fastening device (metal plate or plastic sleeve). Refer to Table 1.19 to define the proper fastener length.

Site pull-out tests

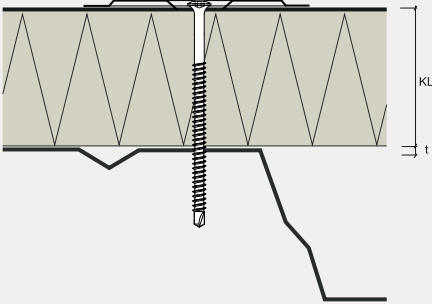
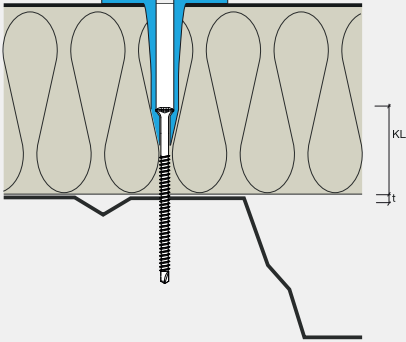
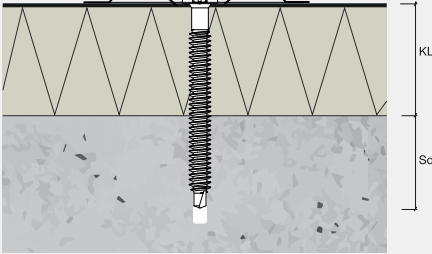
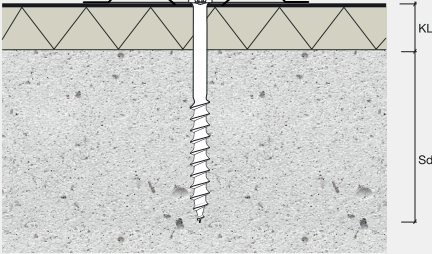
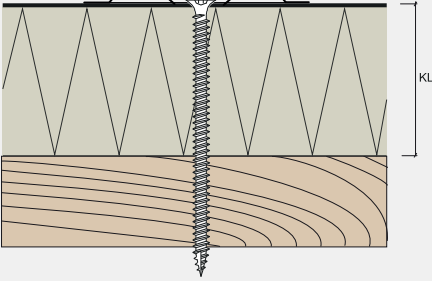
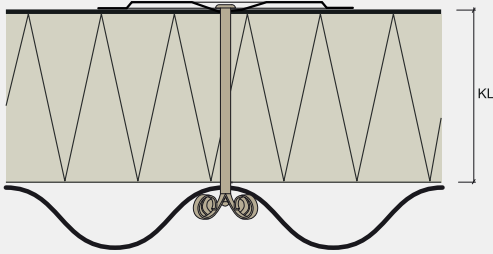

Picture 1.69

Site pull-out tests will need to be conducted on re-roofing projects, in case of degradable supports, on thinner steel decks or on all projects where doubt exists about the quality of the substrate.

Firestone recommends that on-site tests are conducted by a representative of the fastener supplier/manufacturer or an independent testing organization to determine actual pull-out values.

All sections of the substrate where integrity is in question should be tested. Test areas shall include corners and perimeters.

The minimum number of pull-out tests required is in relation to the roof size, as indicated in Table 1.20.

REQUIREMENTS SITE PULL-OUT TESTS	
ROOF SIZE (m ²)	MINIMUM NUMBER PULL-OUTS
< 1,000	6
1,000 - 5,000	10
5,000 - 10,000	20
> 10,000	1 per 500 m ²

Table 1.20 - Requirements site testing pull-out

When new construction prevents preliminary on-site tests, the deck manufacturer should supply estimated pullout values for design and estimating purposes. On-site verification of the pull-out capacity shall be confirmed.

In case the substrate cannot provide the required minimum value, contact Firestone's technical department for design of an alternative system based on the actual fastener pull-out value.

Adhesive systems

Insulation and cover boards should be attached to a dry, clean and appropriate substrate with low rise foam adhesive. Firestone supplies I.S.O. Twin Pack™ adhesive for this application. Contact Firestone's technical department for approval of an alternative system.

UltraPly™ TPO membranes can only be adhered to a suitable substrate (deck, existing roof membrane, insulation board with appropriate facer, cover board) using an adhesive supplied by Firestone. Refer to Table 1.21 to select an appropriate adhesive.





SECUREMENT INSULATION AND COVER BOARDS		
TYPE OF ADHESIVE	DESCRIPTION	APPLICATION CONDITIONS
 <p>Picture 1.70</p>	<p>The Firestone I.S.O. Twin Pack is a two-component low-rise polyurethane adhesive designed for bonding roof insulation and cover boards to an acceptable substrate, as well as for adhering multiple layers of insulation.</p>	<p>Can be applied at temperatures as low as -7 °C. It is applied in beads using a dispenser. Spacing between beads depends on wind load design.</p>
SECUREMENT ULTRAPLY TPO MEMBRANE		
TYPE OF ADHESIVE	DESCRIPTION	APPLICATION CONDITIONS
 <p>Picture 1.71</p>	<p>The Firestone UltraPly™ Bonding Adhesive is a solvent-based contact adhesive designed for bonding Firestone UltraPly™ TPO membranes to approved insulation and cover boards, in addition to wood, metal, masonry, concrete and other acceptable substrates.</p>	<p>Apply the adhesive at about the same time onto both surfaces to be adhered to allow the same drying time. Use a solvent-resistant roller. The adhesive can also be dispensed in a more efficient way using SuperSpreader or BetterSpreader equipment.</p>
 <p>Picture 1.72</p>	<p>The Firestone BA-2012 Bonding Adhesive is a solvent-based contact adhesive designed for bonding Firestone UltraPly™ TPO membranes to approved insulation and cover boards, in addition to wood, metal, masonry, concrete and other acceptable substrates.</p>	<p>Apply the adhesive at about the same time onto both surfaces to be adhered to allow the same drying time. Use a solvent resistant roller. The adhesive can also be dispensed in a more efficient way using a Super Spreader or Better Spreader equipment. Application temperatures vary between 5°C and 30°C.</p>
 <p>Picture 1.73</p>	<p>The Firestone BA-2012 S Bonding Adhesive is a sprayable solvent-based contact adhesive designed for bonding Firestone UltraPly™ TPO membranes to approved insulation and cover boards, in addition to wood, metal, masonry, concrete and other acceptable substrates.</p>	<p>Only recommended for bonding UltraPly™ TPO membranes at upstands and skylight curbs. Try to apply the correct amount of adhesive in a single layer. Application temperatures vary between 5°C and 30°C.</p>
<p>Note: The BA 2012 and BA 2012 S adhesives contain more solids (less solvents) than the UltraPly™ Bonding Adhesive. As a result, these adhesives dry faster, are less sensitive to humidity and are more efficient to apply in winter time.</p>		

Table 1.21 – Applicability Firestone adhesives

1.5.5 Insulation and cover board attachment



Picture 1.74

Positioning

- Insulation boards and cover boards must fit neatly to all roof penetrations, projections, upstands, etc. Joints between boards should be limited (max. 5 mm) and the final surface needs to be as smooth as possible to facilitate the installation and welding of the membrane.
- Good roofing practice recommends that insulation be installed with the long ends running in a direction perpendicular to the flutes of the deck and the short ends staggered (Picture 1.75). In case of multiple layers of insulation, the second layer must be installed with staggered joints to avoid thermal bridging.
- Insulation and cover boards should have a minimum size, in particular at perimeters, skylights and around roof penetrations to install a continuous fastening pattern in a secure way and to avoid difficulties for welding. Consult the insulation manufacturer for specific instructions.
- Care should be taken not to install more boards than can be covered with UltraPly™ TPO membrane before the end of each working day or the onset of inclement weather.
- Cover boards should always be attached to the substrate and can never be loosely laid.
- Insulation boards can be loosely laid when the covering membrane and ballast are installed immediately following installation of the insulation. In all other situations, the insulation needs to be attached in accordance with one of the 3 methods described on the following pages.

Mechanical fastening with plates or sleeves



Picture 1.75



Picture 1.76

This method is commonly used when the roofing membrane is mechanically fastened to the deck (using seam plates) or fully adhered.

The insulation boards are anchored to the deck with an approved combination of fastening plate or plastic sleeve and fastener. Make sure all fasteners have the proper length.

Roofing systems where the membrane is secured with seam plates require that insulation attachment is designed independently from the requirements for membrane securement. Additional fasteners may be required in areas of high wind loads, around perimeters and in the corners of the roof for code compliance. Consult local wind uplift standards for additional information.

Insulation boards also require a minimum number of fasteners per board, independent from wind uplift calculations, to assure dimensional stability. This is in particular important for PIR and PUR boards to prevent warping. The minimum fastening rates and patterns vary in function of type, size and thickness of the insulation.

Insulation boards should therefore be installed in accordance with the instructions of the manufacturer (fastening rates and patterns) and in accordance with the following guidelines:

- Fasteners can only be anchored in the flutes of the deck
- Plates or sleeves need to be distributed in a uniform and (as much as possible) symmetrical way over the board
- Fasteners need to be installed maintaining always a minimum distance of 100 mm from the edges
- Spacing between fasteners need to be as uniform as possible and minimum 200 mm
- Smaller pieces of board used to fit at upstands and around detailing should be considered as other boards and require a minimum density of fasteners and also a minimum size.

Minimum fastening rates Firestone PIR insulation

Thickness (mm)	600 mm x 1200 mm board	1200 mm x 1200 mm board	1200 mm x 2400 mm board
MECHANICALLY FASTENED SYSTEM			
30	4	4	6
50	4	4	6
> 50	4	4	6
FULLY ADHERED SYSTEM			
30	4	8	16
50	4	6	12
> 50	4	5	8

Table 1.22 - Minimum number of fasteners/ plates per Firestone PIR board.

When using Firestone PIR insulation, all boards need to be installed with the bottom facer (marked "This side down") onto the deck. This is particularly important for fully adhered roofing systems.

Refer to Table 1.22 for minimum fastening rates of Firestone PIR insulation in function of the insulation board thickness and the selected method to attach the membrane.

Fastening patterns Firestone PIR insulation

The following fastening patterns can be used to attach Firestone PIR insulation on wooden and concrete decks.

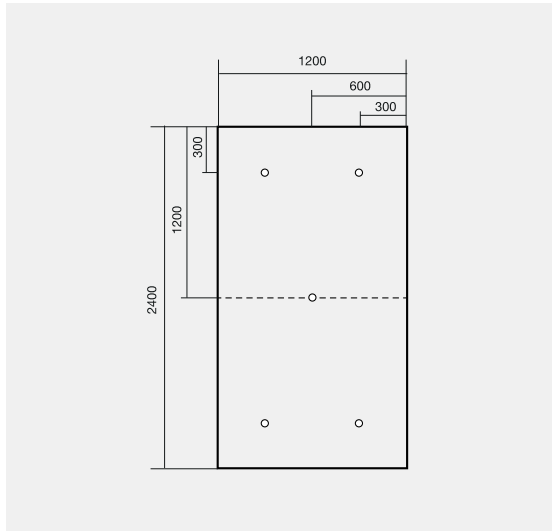

Figure 1.16-1

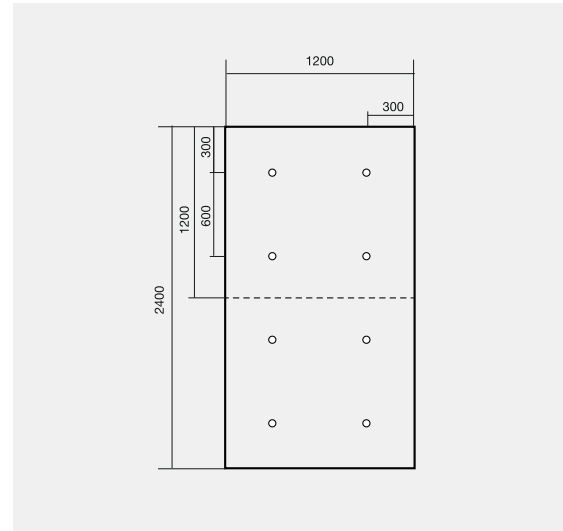

Figure 1.16-2

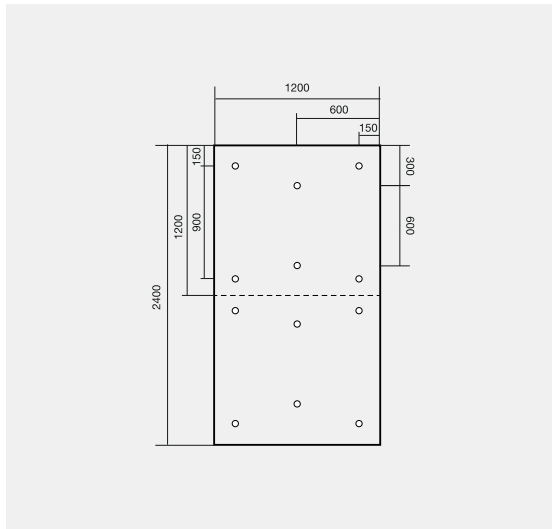

Figure 1.16-3

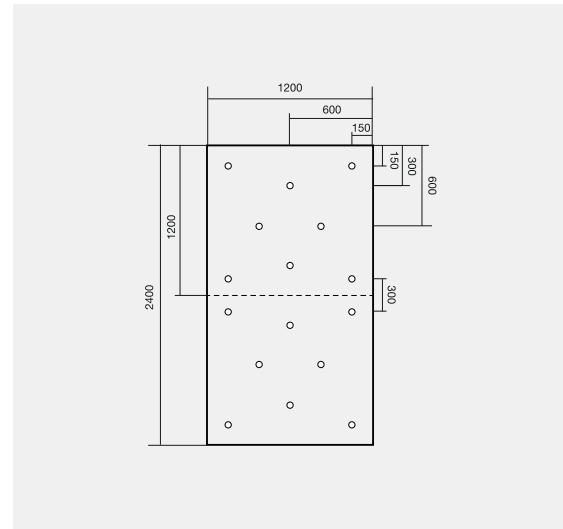

Figure 1.16-4

Figure 1.16 Fastening patterns Firestone PIR insulation on wood/ concrete/ SW panels

When installing over profiled metal decks, the above illustrated patterns will need to be adapted in function of the deck profile.

Contact a Firestone technician or Firestone's technical department for assistance with design of an acceptable pattern.

Mechanical fastening with TPO induction welding plates



Picture 1.77



Picture 1.78

This method is used on roofing projects where the membrane is secured with the induction welding method. The use of TPO induction welding plates is only applicable on suitable substrates (smooth, clean and dry), approved insulation boards (sufficient compressive strength, acceptable facer) and on cover boards.

The top boards of the roofing system are mechanically anchored to the deck with approved TPO induction welding fastening plates and fasteners.

- The fastening pattern of the plates should be a symmetrical design, determined for each individual roof area (field, perimeter, corner) in compliance with the designed wind load, the pull-out resistance of the fastener/deck system and the type and thickness of the top layer of insulation (when installing a multilayer insulation).
- As roofs have distinct areas of wind pressure, these zones have to be determined first before installation of the fastening plates. Each of these areas will have its own rate of attachment. The fastening pattern needs to take into consideration the design of the roof deck, fastening requirements for the roofing membrane and the specifications of the insulation manufacturer (minimum fastening rate).
- Follow a straight line, linear pattern or grid pattern as illustrated. This allows the plates below the membrane to be located easily, making installation and inspection easier. Increased fastening density is obtained by decreasing the spacing between fastener rows in one or both directions. On the illustration, insulation boards have been fastened with following densities (fasteners per board) 1 - Center (8), 2 - Perimeter (15), 3 - Corner (20)
- Consult local wind uplift standards for additional information and contact Firestone's technical department for assistance in developing the correct fastening pattern.

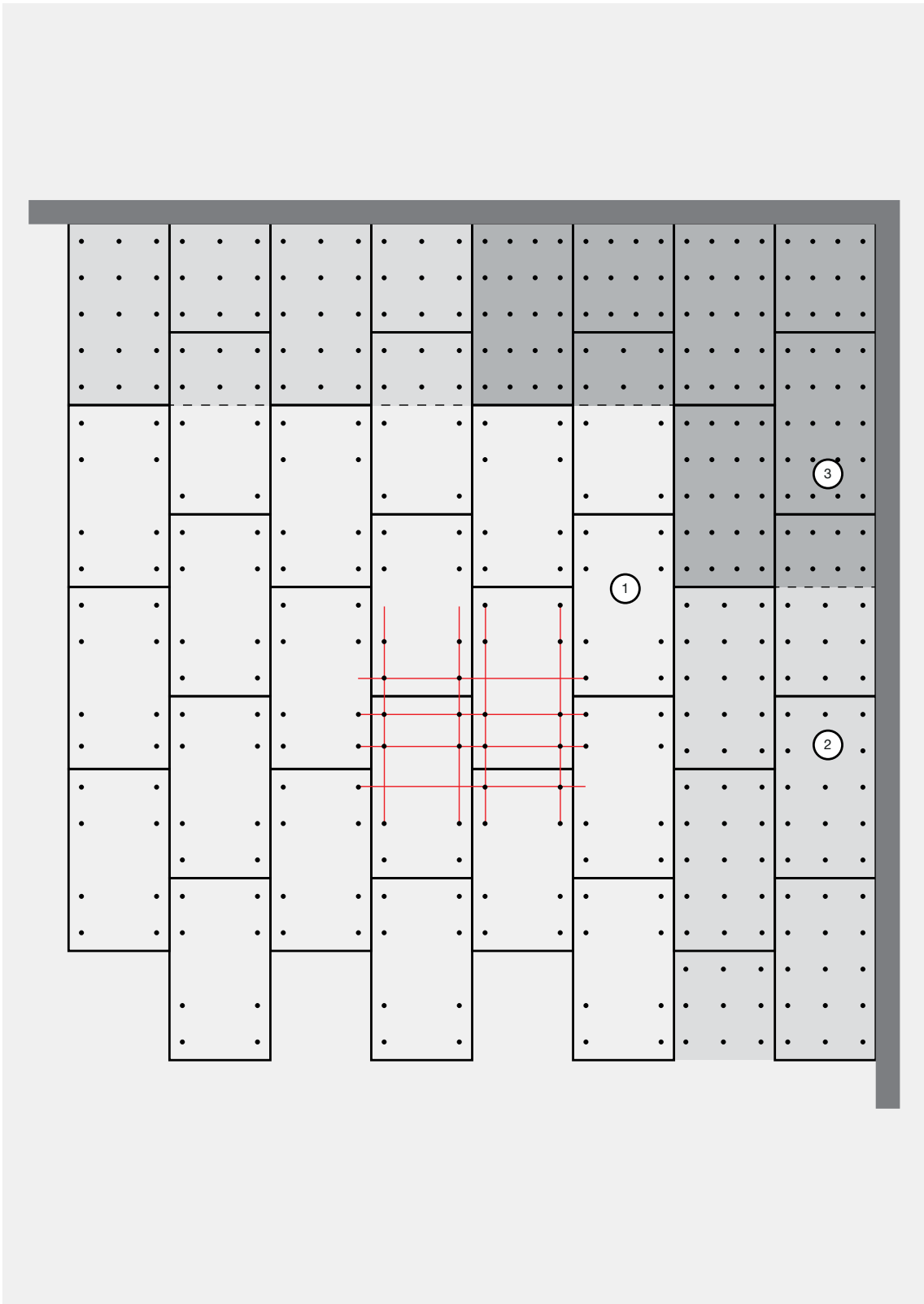

Figure 1.17 - Layout pattern TPO induction welding plates

Attachment with foam adhesive



Picture 1.79

This method of attachment is applicable on roofing systems where perforation of the roof deck, air barrier or vapor control layer is not allowed or where cold bridges are not accepted. This method is also applied on projects where mechanically fastened systems are not practical.

- Firestone only allows insulation attachment with an approved low-rise foam adhesive and does not allow insulation attachment with hot bitumen.
- The number of beads per m² (or spacing between beads) and the quantity of adhesive applied is in function of wind uplift conditions in the respective wind zone.
- Acceptable substrates are:
 - Poured, pre-cast and light weight concrete decks, provided they are structurally sound. Poured decks must have a minimum 28 day drying time.
 - Steel decks and Wooden decks.
 - Vapor control layers, with exception of poly-ethylene films, provided they are firmly attached to the deck.
 - Existing bituminous membranes with smooth or mineral surface.
 - Insulation boards with appropriate facers.
- This method is not applicable directly on existing single ply roofing membranes.

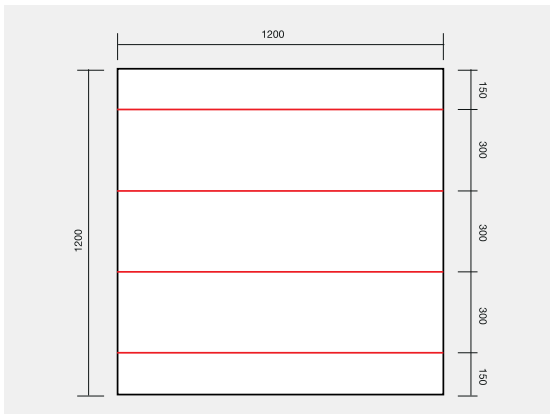

Figure 1.18 - Pattern of adhesive on wood / concrete / SW panels

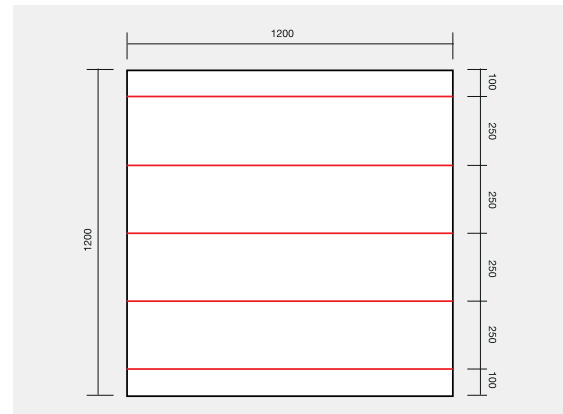

Figure 1.19 - Pattern of adhesive on wood / concrete / SW panels

- Follow the instructions of the adhesive supplier for application conditions (temperature of air and surface, preparation of substrate, maximum size of insulation boards) and installation requirements (minimum spacing between beads, walk in of insulation to ensure proper bond, etc.).
- Firestone recommends the installation of maximum 1200 x 1200 boards. On wood, concrete and SW panels one of the patterns illustrated below can be used to apply the adhesive. Higher wind-uplift pressures can be absorbed by reducing the spacing between the beads.

1.5.6 Membrane attachment



Picture 1.80

Positioning

Firestone UltraPly™ TPO membranes need to be attached to the substrate or deck at three locations: in the field of the roof (horizontal), against parapets and walls (vertical) and at the base of upstands (angle change) and around roof penetrations.

In this section we will review the four different options to secure the UltraPly™ TPO membrane in the field of the roof (on the horizontal).

It is the responsibility of the contractor to verify if the substrates to be covered are appropriate and provide the required conditions to secure the membrane.

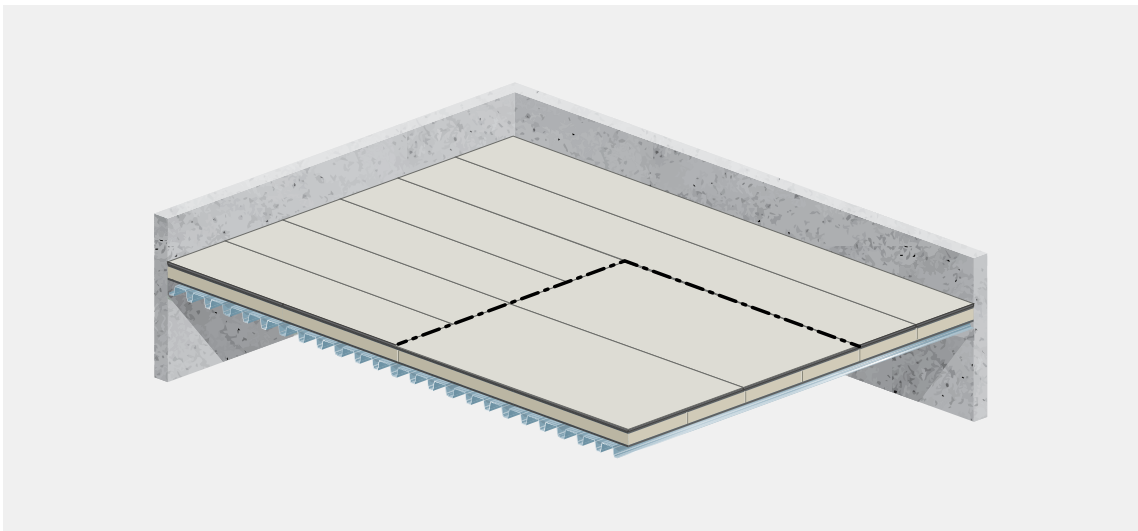

Figure 1.20 - Layout UltraPly™ TPO panels in MEC system over steel deck

The direction to unroll and position the membrane panels is only important on metal decks where the membrane will be mechanically fastened in the seam. In this case, membrane panels have to be positioned in a direction perpendicular to the flutes to optimize distribution of the wind loads. In all other situations, membrane panels are in preference unrolled following the slope.

Mechanical fastening in the seam



Picture 1.81



Picture 1.82

This is the most commonly applied method. Roofing membranes are anchored to the deck with Firestone barbed seam plates and fasteners or an appropriate alternative system. The fastening system is installed within the overlapping side laps.

The fastening plates need to be positioned correctly in the overlap of adjoining side seams to allow sufficient margin for welding.

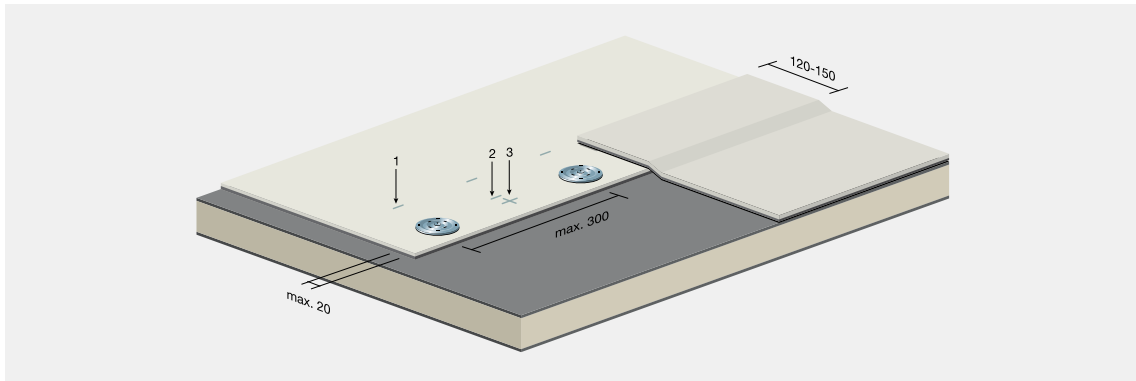

Figure 1.21 - Position Firestone fastening devices within seam

In case Firestone barbed seam plates are used, Firestone recommends installing adjoining panels with a side overlap of 150 mm. All UltraPly™ TPO membrane panels are marked at one edge to facilitate the installation of Firestone seam plates (Ø 50 mm) with a safe margin. Side overlaps can be reduced to 120 mm when using smaller plates or washers (width or Ø - 40 mm).

When installing over metal decks, the spacing between fasteners is determined by the profile of the deck.

Fastener layouts should be determined in compliance with the designed wind load and pull-out resistance of the fastener/deck system.

Perimeter and corner areas require therefore a higher density of fasteners. This is usually resolved by installing panels with smaller width or half sheet panels. Refer to Table 1.5 to select the most appropriate panel width.

There are three alternative solutions to avoid the use of smaller panels:

- Installation of a row of fasteners on top of the membrane, covered with a cover strip
- Application of the induction weld system (see further)
- Application of a fully adhered system with an increase of the number of fasteners in these areas to attach the insulation.

On sandwich panels, it is recommended to follow the instructions of the deck supplier.

Membrane attachment with induction welding



Picture 1.83

- All plates need to be properly installed to create a perfect smooth surface for welding.
- UltraPly™ TPO membrane panels are to be welded using a heat induction process on a grid of TPO induction welding fastening plates that is mechanically anchored to the deck.
- Maximum 3.05 m wide panels are used in all roof areas with side and end overlaps of minimum 75 mm. Positioning of the membrane panels is not determined by the installation of the steel deck.
- Avoid to align seams with rows of plates, as the step-down may cause an incomplete weld onto the fastening plate.
- Keep 50 mm between the membrane seam and the edge of the fastening plate.

Membrane attachment with contact adhesive



Picture 1.84

- Make sure that the substrate to be covered (existing roof membrane, insulation, cover board) is sufficiently anchored to the deck.
- In case of mechanical attachment of insulation or cover-board, the number of fasteners must be increased in corner and perimeter zones.
- Maximum 3.05 m wide panels are used with side and end overlaps of minimum 75 mm. Positioning of the membrane panels is not determined by the installation of the steel deck.
- UltraPly™ TPO membrane panels are to be fully (100%) bonded onto the substrate with a Firestone contact adhesive. The adhesive is to be applied to both mating surfaces, the substrate and the back side of the membrane.
- Coverage rates may vary in function of type of adhesive, substrate, temperature and equipment. Contact a Firestone technician or Firestone's technical department for more detailed information regarding application and required coverage rates. A spreading equipment can be used to make application more efficient.
- Verify that all surfaces to be covered with adhesive provide appropriate conditions for bonding (dry and clean).

Membrane securement with ballast



Picture 1.85



Picture 1.86



Picture 1.87

UltraPly™ TPO membranes can also be secured with gravel or concrete pavers. Installation of the membrane over a concrete substrate is only allowed with a separation layer (geotextile). Direct contact between membrane and substrate must be avoided in a ballasted roofing system.

- Roofing systems where the roofing membrane will be secured with ballast do not require an additional attachment of the insulation. Additional attachment of the insulation is only allowed with foam adhesive or mechanically by using plastic sleeves.
- Installation over loosely laid cover boards is not allowed.
- The designer shall be responsible for design and selection of the ballast. Refer to local codes for information regarding requirements for coverage rates.
- Ballast shall be of adequate size and weight as to provide proper protection against wind uplift. UltraPly™ TPO membranes must be fully covered in case gravel is used.
- Specific attention is required regarding the timing for the installation of the ballast. Roof areas need to be covered as soon as possible with ballast after installation of the membrane. This can only be done after completion and final control of all welded seams.
- Use of temporary ballast may be required to prevent lifting of the membrane and shifting of the insulation boards.

Refer to Table 1.23 to identify materials to be used for ballast and according recommendations for membrane protection.



SECUREMENT TPO MEMBRANE		
TYPE OF BALLAST	DESCRIPTION	APPLICATION CONDITIONS
 <p><i>River-washed aggregate</i></p>	<p>Smooth, river-washed aggregate with rounded edges without broken pieces Nominal 16/32 Minimum weight of 50 kg/m²</p>	<p>NO REQUIREMENT</p>
 <p><i>Crushed stones</i></p>	<p>Crushed stones, free of excessive fractures, sand or foreign substances. Minimum weight of 50 kg/m²</p>	<p>Geotextile (min. 200 gr/m²)</p>
 <p><i>Concrete pavers</i></p>	<p>50 mm thick concrete pavers with smooth trowel finish. Maximum spacing between pavers should be 10 mm.</p>	<p>Geotextile (min. 200 gr/m²) or Extruded Polystyrene</p>

Table 1.23 - Protection requirements UltraPly™ TPO membrane panels

1.5.7 System selection tables



It has become increasingly difficult for manufacturers of roofing membranes to provide simple guidance on design, as the roofing industry offers a wide range of options for structural decks, insulation boards, cover boards, membranes, fastening systems and other accessories.

The following four tables cater for projects that are installed on the most commonly used decks, including steel decks, in-situ concrete, pre-cast concrete and wooden decks. Each table provides information to determine the most appropriate UltraPly™ TPO roofing system. For a good understanding, we hereby define 'system' as the method to attach the membrane.

There are 5 Firestone UltraPly™ TPO roofing systems referred in this document: mechanically fastened, induction welded, fully adhered, ballasted and inverted.

By consulting the relevant selection table, designers and contractors will find general information on required structural conditions and finishing of the roof deck (quality, load bearing capacity, slope), as well as technical requirements for all roof components underneath the membrane (thermal insulation, substrate, etc.).

More specific information on roof components (membrane, insulation, fasteners, etc.), substrate and re-roofing considerations, methods to secure membrane and insulation can be found in the corresponding sections of this chapter and in Chapter 3.

Installation of a Firestone UltraPly™ TPO roofing system over structural decks and insulation boards other than the ones mentioned in the following charts are only accepted following approval by Firestone's technical department.

Finally, we recommend to contact Firestone's technical department for more specific information regarding fire and wind uplift performance of the selected system. Requirements of local codes may have an impact on the selection of the insulation board (type, quality of facer), the method to secure the membrane and its thickness.

Steel deck (1)

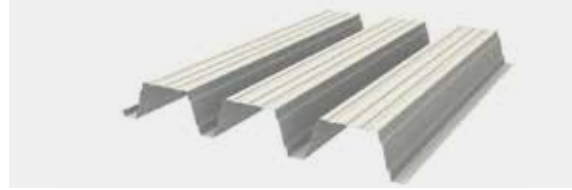

THERMAL INSULATION	EPS	XPS	PUR	PIR	MW	WF	CG
FIRESTONE SYSTEM	Mechanically fastened (3,4,6)	Mechanically fastened (3,4,6)	Mechanically fastened (3,10)	Mechanically fastened (3)	Mechanically fastened (3,5)	Mechanically fastened (3,4)	Mechanically fastened (6,9,11)
	Induction welding (3,4,6)	Induction welding (3,4,6)	Induction welding (3,7,10)	Induction welding (3,7)	Induction welding (3,5,9)	Induction welding (3,4)	Induction welding (6,9,11)
	Fully adhered (3,4,6)	Fully adhered (3,4,6)	Fully adhered (3,8,10)	Fully adhered (3,8)	Fully adhered (3,5,6)	Fully adhered (3,6)	Fully adhered (3,11,12)
	Ballasted (2,3,4)	Ballasted (2,3,4)	Ballasted (2,3)	Ballasted (2,3)	Ballasted (2,3,5)	Ballasted (2,3)	Ballasted (2,3,6)
DESIGN CRITERIA	<p>Structural conditions</p> <ul style="list-style-type: none"> (1) Metal decks require a minimum thickness of 0.75 mm Mechanical attachment into thinner decks (re-roofing and upstands) requires special consideration pull-out and application of an appropriate fastening system (2) Minimum load bearing capacity required (3) Verify roof slope as it may be a limiting condition <p>Thermal insulation</p> <p>Installation of a vapor control layer should be determined by the designer</p> <ul style="list-style-type: none"> (4) Minimum density required (5) High compressive strength (6) Requires an appropriate and approved overlayer (geo-textile or cover board) (7) Top facer must be compatible so as to allow induction (8) Top facer must be compatible so as to provide sufficient adhesion (9) Requires application of an adjusted fastening device (10) Verify fire rating, since not all PUR boards provide similar ratings as PIR (11) Cellular glass boards are to be secured to the deck using polyurethane adhesive. (12) Requires installation of modified bituminous underlayer (APP or SBS) fully torched on cellular glass board, at least 4 weeks before installation of TPO membrane or installation of an approved cover board. 						

Table 1.24

In-situ concrete (1)



THERMAL INSULATION	EPS	XPS	PUR	PIR	MW	WF	CG	DIRECT APPLICATION
FIRESTONE SYSTEM	Ballasted (2,3,4)	Inverted/ Ballasted (2,3)	Ballasted (2,3)	Ballasted (2,3)	Ballasted (2,3)	Ballasted (2,3)	Ballasted (2,3,6)	Ballasted (2,3,13)
	Mechanically fastened (3,4,6)	Mechanically fastened (3,6)	Mechanically fastened (3,10)	Mechanically fastened (3)	Mechanically fastened (3,5)	Mechanically fastened (3,4)	Mechanically fastened (6,9,11)	Mechanically fastened (3,13)
	Induction welding (3,4,6)	Induction welding (3,6)	Induction welding (3, 7,10)	Induction welding (3, 7)	Induction welding (3, 5, 9)	Induction welding (3, 4)	Induction welding (6,9,11)	Induction welding (3,6)
	Fully adhered (3,4,6)	Fully adhered (3,4,6)	Fully adhered (3,8,10)	Fully adhered (3,8)	Fully adhered (3,5,6)	Fully adhered (3,6)	Fully adhered (3,11,12)	Fully adhered (3,14)
DESIGN CRITERIA	<p>Structural conditions</p> <ul style="list-style-type: none"> (1) Concrete needs to be structurally sound and dry. Consult Firestone's technical department for more information about the procedure to check moisture content of concrete Mechanical attachment in situ-concrete requires special consideration and use of an appropriate fastening system (2) Minimum load bearing capacity required (3) Verify roof slope as it may be a limiting condition <p>Thermal insulation</p> <p>Installation of a vapor control layer should be determined by the designer</p> <ul style="list-style-type: none"> (4) Minimum density required (5) High compressive strength (6) Requires an approved overlayment (geo-textile or cover board) (7) Top facer must be compatible so as to allow induction (8) Top facer must be compatible so as to provide sufficient adhesion (9) Requires application of an adjusted fastening device (10) Verify Fire rating, since not all PUR boards provide similar ratings as PIR (11) Cellular glass boards are to be secured to the deck using polyurethane adhesive. (12) Requires the installation of a modified bituminous underlayer (APP or SBS) fully torched on cellular glass board, at least 4 weeks before installation of the TPO membrane or installation of an approved cover board. <p>Substrate</p> <ul style="list-style-type: none"> (13) Installation of a protective mat (geotextile, minimum 200 gr/m²) or recovery board is required over rough/uneven substrates. (14) If the substrate is smooth (wood float finished), clean, dry, free of sharp edges, fins, loose or foreign materials, oil, grease or products which may damage the system. 							

Table 1.25



Pre-cast concrete (1)



THERMAL INSULATION	EPS	XPS	PUR	PIR	MW	WF	CG	DIRECT APPLICATION
FIRESTONE SYSTEM	Ballasted (2,3,4)	Inverted/ Ballasted (2,3)	Ballasted (2,3)	Ballasted (2,3)	Ballasted (2,3,5)	Ballasted (2,3)	Ballasted (2,3,6)	Ballasted (2,3,13)
	Mechanically fastened (3,4,6)	Mechanically fastened (3,6)	Mechanically fastened (3,10)	Mechanically fastened (3)	Mechanically fastened (3,5)	Mechanically fastened (3,4)	Mechanically fastened (6,9,11)	Mechanically fastened (3,13)
	Induction welding (3,4,6)	Induction welding (3,6)	Induction welding (3, 7,10)	Induction welding (3, 7)	Induction welding (3, 5, 9)	Induction welding (3, 4)	Induction welding (6,9,11)	Induction welding (3,13)
	Fully adhered (2,3,4)	Fully adhered (3,6)	Fully adhered (3,8,10)	Fully adhered (3,8)	Fully adhered (3,5,6)	Fully adhered (3,6)	Fully adhered (3,11,12)	Fully adhered (3,14)
DESIGN CRITERIA	<p>Structural conditions</p> <ul style="list-style-type: none"> (1) Precast concrete decks are usually supplied as slabs and often made with hollow cores to minimize weight. Panels must be structurally sound and dry. Deformed panels must be replaced. Joints must be filled with a sand and cement mortar to correct imperfections. Joints that cannot be finished smooth require the installation of either a lightweight concrete screed, a cover board or thermal insulation. Mechanical attachment in situ-concrete requires special consideration and use of an appropriate fastening system (2) Minimum load bearing capacity required (3) Verify roof slope as it may be a limiting condition <p>Thermal insulation</p> <p>Installation of a vapor control layer should be determined by the designer</p> <ul style="list-style-type: none"> (4) Minimum density required (5) High compressive strength (6) Requires an approved overlayerment (7) Top facer must be compatible so as to allow induction (8) Top facer must be compatible so as to provide sufficient adhesion (9) Requires application of an adjusted fastening device (10) Verify Fire rating, since not all PUR boards provide similar ratings as PIR (11) Cellular glass boards are to be secured to the deck using a polyurethane adhesive. (12) Requires the installation of a modified bituminous underlayer (APP or SBS) fully torched on cellular glass board, at least 4 weeks before installation of TPO membrane or the installation of an approved cover board. <p>Substrate</p> <ul style="list-style-type: none"> (13) Installation of a protective mat (geotextile, minimum 200 gr/m²) or recovery board is required over rough/uneven substrates. (14) Requires the installation of a smoothly finished screed or an approved cover board. 							

Table 1.26



Wooden deck (1)



THERMAL INSULATION	EPS	XPS	PUR	PIR	MW	WF	CG	DIRECT APPLICATION
FIRESTONE SYSTEM	Mechanically fastened (3,4,6)	Inverted (2,3)	Mechanically fastened (3,10)	Mechanically fastened (3)	Mechanically fastened (3,5)	Mechanically fastened (3,4)	Mechanically fastened (6,9,11)	Mechanically fastened (3,14)
	Induction welding (3,4,6)	Mechanically fastened/ Induction welding (3,6)	Induction welding (3,7,10)	Induction welding (3,7)	Induction welding (3,5,9)	Induction welding (3,4)	Induction welding (6,9,11)	Induction welding (3,14)
	Fully adhered (3,4,6)	Fully adhered (3,6)	Fully adhered (3,8,10)	Fully adhered (3,8)	Fully adhered (3,5,6)	Fully adhered (3,6)	Fully adhered (3,11,12)	Fully adhered (3,14)
	Ballasted (2,3,4)	Ballasted (2,3)	Ballasted (2,3)	Ballasted (2,3)	Ballasted (2,3,5)	Ballasted (2,3)	Ballasted (2,3,6)	Ballasted (2,3,13)
DESIGN CRITERIA	<p>Structural conditions</p> <ul style="list-style-type: none"> (1) Acceptable structural decks are: Timber boards (well seasoned, tongued and grooved) with minimum thickness 19 mm, Exterior Grade Plywood or OSB (Oriented Strand Board) class EUR 3 with a minimum thickness of 18 mm (2) Minimum load bearing capacity required (3) Verify roof slope as it may be a limiting condition <p>Thermal insulation</p> <p>Installation of a vapor control layer should be determined by the designer</p> <ul style="list-style-type: none"> (4) Minimum density required (5) High compressive strength (6) Requires an approved overlayment (7) Top facer must be compatible so as to allow induction (8) Top facer must be compatible so as to provide sufficient adhesion (9) Requires application of an adjusted fastening device (10) Verify fire rating, since not all PUR boards provide similar ratings as PIR (11) Cellular glass boards are to be secured to the deck using a polyurethane adhesive. (12) Requires the installation of a modified bituminous underlayer (APP or SBS) fully torched on cellular glass board, at least 4 weeks before installation of the TPO membrane or the installation of an approved cover board. <p>Substrate</p> <ul style="list-style-type: none"> (13) Installation of a protective mat (geotextile, minimum 200 gr/m²) is required over rough substrates (14) Acceptable over plywood/OSB if the surface is clean, dry, smooth, free of sharp edges, fins, loose splinters, foreign materials, oil, grease and other products which oil, grease or products that may damage the membrane. Timber decks require the installation of a cover board. 							

Table 1.27

1.6 Detailing



Picture 1.90



Picture 1.91

Proper design and location of roof penetrations is required to facilitate the installation and proper detailing of the Firestone UltraPly™ TPO roofing system.

Obstructions need to be positioned with sufficient spacing to create appropriate conditions for welding and installation of flashings, and to minimize situations that require cutting of the field membrane. Firestone therefore recommends a minimum distance of 300 mm between roof penetrations and upstands or other penetrations.

Wherever practical, Firestone recommends the use of pre-shaped accessories of extruded TPO or the application of accessories that are compatible for welding to UltraPly™ TPO membranes.

Skylight curbs, upstands and roof penetrations need to provide sufficient height for flashing. Refer to local codes for minimum requirements.

As previously mentioned in the wind design section, a properly secured membrane at upstands is a critical condition for a safe performance of any roofing system.

1.6.1 Base tie-in



Picture 1.92



Picture 1.93



Picture 1.94



Picture 1.95

Consult local codes for requirements regarding the installation of base tie-in details and the Firestone UltraPly™ TPO details of installation (Chapter 5).

- UltraPly™ TPO membranes need to be mechanically fastened at all locations where the membrane stops (roof edges) or goes through an angle change greater than 15% (base of upstands, base of skylight curbs, interior walls, ridges, valleys, etc.).
- UltraPly™ TPO membranes have to be mechanically fastened either horizontally into the roof deck or vertically into the wall using Firestone HD seam plates or metal bars and an appropriate fastener. Membranes should be anchored at upstands and curbs. Use of other fastening plates is allowed when approved by Firestone's technical department or a Firestone technician.
- Refer to the Firestone UltraPly™ TPO system detail drawings for correct positioning of base membrane and fasteners. Observe that a minimum distance is required between the edge of the fastening plate and the edge of the base membrane.
- Firestone recommends a maximum spacing of 300 mm between fasteners. This may have to be adjusted (< 300 mm) in function of deck profile in case of horizontal attachment.

1.6.2 Flashing of walls and curbs

Parapets, interior walls and skylight curbs should preferably be covered with a fully adhered UltraPly™ TPO membrane. Fully bonded wall flashings provide the best wind uplift resistance and are therefore the preferred method to guarantee a safe wind uplift performance of the roof system.

Firestone recommends removing all existing flashings that are loose (i.e. metal, bituminous materials, mastic, synthetic membranes, etc.).

Fully adhered flashings



Picture 1.96

- Existing bituminous flashings that remain and are to be covered with a fully adhered membrane must provide firm attachment to the substrate and have adequate and continuous inter-ply adhesion.
- Existing bituminous flashings that are coated or loose and cannot be stripped must be overlaid with either insulation, re-cover board, exterior grade plywood or gypsum board prior to installation of the flashing membrane.
- The UltraPly™ TPO membrane needs to be 100% adhered to the substrate using exclusively an appropriate Firestone contact adhesive. Refer to the fastening system section for selection of a suitable adhesive and appropriate coverage rates.
- Porous substrates (rough wood, concrete blocks, etc.) may require an additional coat of adhesive to ensure proper adhesion.
- High wall flashings require the installation of an intermediate attachment using approved plates or bars and fasteners. Refer to Table 1.28 for requirements for attachment.

HEIGHT UPSTAND (m)	REQUIREMENT FOR ATTACHMENT
≤ 1.0	NONE
1.0 - 2.0	At 1/2 height, fastened max. 300 mm o.c.
> 2.0	Every 1.0 m, fastened max. 300 mm o.c.

Table 1.28 - Requirements intermediate attachment - adhered flashings

Mechanically fastened flashings



Picture 1.97



Picture 1.98

Mechanically fastened wall flashings are an alternative solution when the substrate conditions are not suitable for bonding. Care should be taken to ensure that the membrane is not in contact with sharp edges and corners and that it is not unsupported over voids bigger than 5 mm.

One of the two following methods can be used to mechanically fasten the membrane:

- Mechanical fastening in the seam using plates, fastened at max 300 mm o.c (Picture 1.95).
- Induction welding system using TPO induction welding plates anchored into the wall underneath the flashing (Picture 1.96).

Walls with limited height (< 450 mm) only require mechanical fastening at the base tie-in and top. Higher wall flashings require the installation of an intermediate attachment.

Refer to Table 1.29 below for requirements for attachment.

HEIGHT UPSTAND (m)	REQUIREMENT FOR ATTACHMENT
≤ 0.50	NONE
≥ 0.50	Every 0.5 m, fastened max. 300 mm o.c.

Table 1.29 - Requirements intermediate attachment – mechanically fastened flashings

Consult Firestone's technical department for use of an alternative method (mechanical fastening on top of TPO membrane covered with a self adhesive cover strip of Ultraply™ TPO membrane) in case of repairs.

1.6.3 Roof penetrations

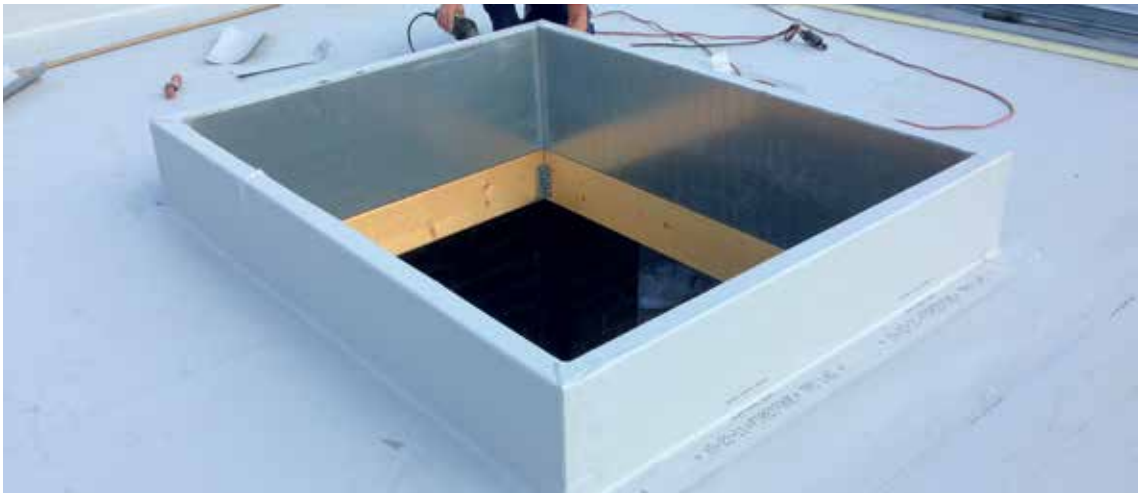

Picture 1.99



Picture 1.100



Picture 1.101



Picture 1.102



Picture 1.103

All penetrations passing through the membrane (pipes, vents, technical equipment, skylights, life line anchor points and lightning rods) need to be firmly attached to the roof structure prior to the installation of the roofing system. In case roof penetrations (skylights, vents,) are installed after securement of the membrane, Firestone recommends to prepare the roof structure and to provide a solid base for anchoring.

Firestone UltraPly™ TPO membranes should also be mechanically fastened at all locations where the membrane stops (drains, scuppers, overflows, etc.).

Exceptions can be made for small roof penetrations, round ($\varnothing < 125$ mm) or square (size $< 100 \times 100$ mm), when the roofing membrane is fully adhered to the substrate.



Skylights

- Skylights should be firmly secured to the substrate using acceptable fasteners (max. 300 mm o.c.). Bowing of the skylight flange between fixings is not allowed. The standard base tie-in detail is substituted by fastening of the skylight flange, in case the skylight has been mounted on top of the field membrane.
- The substrate of the skylight curb should be compatible with Firestone contact adhesives and flashing materials. Installation of a cover board may be required in case flashing membranes are to be adhered, i.e. over MW insulation.
- The flashing seal must be made directly to the skylight frame.

Pipe penetrations

- Remove all loose existing flashings (i.e. metal, bituminous materials, mastic, etc.) in re-roofing projects.
- All penetrations passing through the membrane should be flashed. The flashing seal must be made directly to the penetration. Refer to local codes for requirements for flashing height.
- Hot pipes (surface temperature > 60°C) require the installation of an insulating sleeve prior to being flashed.
- Whenever possible, round pipe penetrations should be flashed with pre-molded Firestone UltraPly™ TPO Pipe Flashings. Pre-molded Pipe Flashings should never be cut or patched during installation.
- Use Firestone UltraPly™ TPO Unsupported Flashing when the use of a pre-molded Pipe Flashing is not possible, as illustrated in Chapter 3.
- Not all roof penetrations can be flashed directly. The following situations require the installation of a penetration pocket:
 - Flexible pipes
 - Cluster of pipes
 - Penetrations with unusual shape, such as structural beams, channels, etc.
 - Pipes with inadequate space for welding and installation of flashing.

Equipment mountings

- Rooftop equipment should be mounted in a way to provide adequate flashing height (min. 300 mm above level of membrane) for installation of the roofing system. There must be sufficient clearance under and around the equipment to facilitate welding and proper sealing.

Drains and overflows

- Always refer to local codes for the design of drains, gutters and overflows.
- Drains and overflows should always be located at the lowest points of the roof, never near columns.
- There are several drain systems that are compatible with UltraPly™ TPO roofing systems. Firestone requires that either drains with a clamping system or insert pieces are used to assure a secure and durable connection with the UltraPly™ TPO membrane.
- Pre-shaped pieces need to be tested on weldability prior to use. Contact Firestone's technical department for a list of applicable drainage systems or consult a Firestone technician in case of doubt regarding weldability.
- Use a specific drainage system for roofing projects where a secure sealing at level of the vapor control layer is required (double insert piece with connection at 2 levels).
- The roofing membrane needs to be additionally mechanically fastened to the deck around drains using an insert piece.

Refer to Chapter 3 for installation of the most commonly applied systems.



1.6.4 Wall and roof edge terminations



Picture 1.104



Picture 1.105

Firestone UltraPly™ TPO membranes need to be securely anchored and sealed at all locations where the membrane ends (wall and curb terminations, flat edges, gutters...). Proper design of these details is critical for the long-term performance of the roofing system since these locations are usually exposed to the most severe wind pressures.

Prior to the installation of the selected roof edge detail, the roofing contractor must verify if the substrate provides adequate conditions for a secure and safe termination of the roof system.

All metal work for perimeter terminations must be properly fastened and sealed.

Wall (curb) terminations

- Whenever possible, provide the minimum design height required by local building regulations for upstand and curb terminations. Flashing height shall be at least as high as the potential water level that can be reached as result of a blocked drainage system.
- If existing built-up flashings are to remain, terminations shall be made directly to the vertical substrate and not to the existing waterproofing membrane.
- There are several methods to terminate the Firestone UltraPly™ TPO roofing system at walls.

The most secure way is to cover the upstand completely with UltraPly™ TPO membrane till the roof edge and install either a metal coping, a coping stone or a roof edge profile. TPO coated metal profiles are used to weld the edge of the flashing membrane onto the horizontal part of the profile. This results already in a watertight seal.

When using a surface mounted termination detail (termination bar, counter-flashing) ensure that the substrate offers structural integrity for mechanical fastening of the finishing profile and the wall provides the required conditions (smooth finishing, dry, watertight ...) to execute a constant seal.

Curb flashings require a mechanical fixation at the top. This can be done using a termination bar, a TPO coated metal profile or a galvanized batten bar. In some situations, it is sufficient to end the flashing at the inside of the skylight curb and finish the installation with the proper skylight finishing.

Refer to the detail drawings and the information in Chapter 3 for specific guidelines regarding the execution of wall termination details.

Roof edge terminations

- Flat roof edges are terminated using a roof edge profile that is mechanically anchored into the substrate. When the profile is made from TPO coated metal, the flashing TPO membrane should be welded onto the TPO side of the profile, resulting in a watertight seal.
- Concrete decks may require installation of wood nailers for an easy and proper securement of roof edge profiles.

Contact Firestone's technical department for design of a specific detail when connecting a Firestone UltraPly™ TPO roofing system to an existing roof.

1.7 Protection and maintenance



Picture 1.106

Firestone UltraPly™ TPO membranes and flashings are designed for exposure in extreme climatic conditions and therefore do not require any additional protection against weathering, UV-light and ozone.

However, Firestone recommends the regular inspection of the roofing system (minimum twice a year) to anticipate potential problems and to assure its durability.

Rainwater outlets, scuppers, drains and gutters can become blocked and should be inspected to ensure that roof drainage can perform as designed.

Physical abuse

The UltraPly™ TPO roofing system must be protected against vandalism and mechanical damage by others. Sharp or rough edged foreign materials such as screws, metal shavings, nails, etc. can damage the membrane and should be removed from the roof during inspections.

Use a suitable underlayment (plank, plywood, insulation board, etc..) whenever ladders are used on top of the UltraPly™ TPO system, to avoid damaging the membrane and/or the insulation.

UltraPly™ TPO roofs will accommodate reasonable and limited foot traffic for occasional maintenance but are not designed to support frequent traffic. The building owner is responsible for maintaining walkways in specific areas such as access points to the roof (doorways, ladders, etc.) and on roofs subjected to traffic more frequent than once per month.

For fully adhered, mechanically fastened and induction welded membranes, Firestone recommends the installation of Firestone TPO Walkway pads. Use of concrete Pads is not for mechanically fastened membranes. For ballasted and inverted systems, Firestone requires to substitute the TPO Walkway Pads by concrete pavers within 3 m of the roof edge.

Contamination

All components of the Firestone UltraPly™ TPO roofing system should be protected from discharges such as petroleum-based products, grease, oils (mineral, vegetable), organic-based solvents, animal fats and fresh bitumen. Refer to Chapter 3 for specific information regarding repair in case of contamination. Contact Firestone's technical department for additional information regarding the chemical resistance of the UltraPly™ TPO membrane.

Heat sources

Any direct contact between UltraPly™ TPO membranes, flashings or accessories and steam or heat sources where the in-service temperature is over 60°C should be avoided.

Firestone recommends to install a sacrificial layer around roof units that generate heat.

Roof adjustments

The addition of new details to the roof such as roof lights, drains, extracting fans, etc. will require an adjustment of the existing roofing system. This should be performed by a Firestone licensed roofing contractor.



Firestone
NOBODY COVERS YOU BETTER™

